

MAGNUSON

SUPERCHARGERS

Installation Instructions for:
TVS2650 Supercharger System
2007-2021 Toyota Tundra 5.7L
-Not for Flex Fuel Trucks-



*** PREMIUM GASOLINE FUEL REQUIRED ***



ATTENTION!
Your MAGNUSON SUPERCHARGER kit
is sensitive to corrosion!
Use only the vehicle manufacturer
recommended coolant for your engine in
the intercooler system as well.

Magnuson Products LLC
1990 Knoll Drive, Bldg A, Ventura, CA 93003
(805) 642-8833 phone
magnusonsuperchargers.com

INSTALLATION MANUAL

Magnuson Supercharger Kit: TVS2650 Toyota Tundra 5.7L (Not for Flex Fuel)

Please take a few moments to review this manual thoroughly before you begin work: Make a quick parts check to be certain your kit is complete (see Bill of Material (BOM) parts list inside the accessory box). If you discover shipping damage or shortage, please call our office immediately. Take a look at exactly what you are going to need in terms of tools, time, and experience. Review our limited warranty with care.

Use only premium gasoline fuel, 91 octane or better.

Magnuson Products recommend that you run a minimum of one (1) tank of premium fuel through your vehicle prior to installation of the system to prevent any possible damage that may occur due to running the supercharged engine on lower octane fuel.

Magnuson Products Supercharger systems are designed for engines and vehicles in "GOOD" mechanical condition. Magnuson Products recommend that a basic engine system "Health Check" be performed prior to the installation of this supercharger system. Be sure to check for any pending or actual OBDII codes and fix/repair any of the stock systems/components causing these codes. If there are codes prior to the installation they will be there after the installation.

Magnuson Products also recommend the following services to be performed on your vehicle before starting and running the vehicle post supercharger system installation:

- Fuel Filter change
- Engine oil and filter change using brand name oil (organic or synthetic) and filter
Note: It is VERY IMPORTANT to use the factory specified oil viscosity. The original equipment manufacturer has selected this grade of oil to work with your other engine systems such as hydraulic chain tensioner and variable cam controls. Deviation from this specification may cause these systems to fail or not function properly. Please refer to your owner's manual for the recommended oil viscosity for your engine and application.

- On newer vehicles not requiring new spark plugs it is important to verify the spark plug air gap.

On older vehicles Magnuson Products recommend these additional services to be performed:

- New spark plugs with the air gap set at the factory specifications OR new specifications if required by the installation manual.
- Coolant system pressure test and flush. **NOTE: YOU MUST USE TOYOTA SPECIFIED COOLANT MIXTURE!**

Non "Magnuson Approved" calibrations or "tuning" will Void ALL warranties and CARB certification.

Our supplied calibration is designed for use with the components provided in this kit. Any adjustment to the intake, or exhaust systems or other engine components may adversely affect engine performance and may trigger your check engine light.

Drive belt = Dayco 5081153

Tools Required

- Metric wrench set**
- Metric 3/8" and 1/2" drive metric socket set (standard & deep)**
- 3/8" and 1/2" drive ft-lb. and in-lb. torque wrenches**
- Metric Allen socket set 3/8" drive**
- Metric Allen wrenches**
- Torx socket set 3/8 drive**
- Phillips and flat head screwdrivers**
- Funnel**
- Drain pan**
- Hose cutters**
- Hose clamp pliers**
- Safety glasses**
- Nut driver**
- Compressed air**
- Air gun**
- Heat gun**
- Fuel tank lock-ring tool**
- Anti-seize assembly lube (for spark plugs)**

Contact Information:

Magnuson Superchargers
1990 Knoll Drive, Bldg A
Ventura, CA 93003

Sales/Technical Support Line (805) 642-8833
Websites www.magnusonsuperchargers.com
Email sales@magnusonsuperchargers.com

Table of Contents

Section 1: Initial Preparation	5
Section 2: Coolant Drainage	6
Section 3: Intake Manifold Removal	8
Section 4: Water Bypass Pipe, and Joint Replacement	15
Section 5: Fuel Injector Replacement	28
Section 6: Air Box and Spark Plug Replacement	33
Section 7: Supercharger Preparation and Installation	36
Section 8: Serpentine Belt, Throttle Body and Hose Installation	41
Section 9: Intercooler System Installation	50
Section 10: Intercooler Pump Wiring Connections	62
Section 11: Fuel Pump Replacement	67
Section 12: Coolant Fill, and Final Testing	75

NOTE: This instruction manual follows the process we used to complete this installation on our test vehicle. This does not imply there aren't alternate approaches. If you find a procedure or process that improves the installation, please let us know! We strive to create the most comprehensive and complete instruction manuals available.

Section 1: Initial Preparation

1. **If your kit has a provided handheld tuner follow the instructions in the provided pamphlet to install your tune. Your handheld tuner may not match the one shown.**



2. Your Intercooler system is sensitive to corrosion. It's very important to use the OEM recommended coolant mixture in your supercharger system as well.



3. Your system requires the use of a minimum 91 Octane gasoline fuel. This system is **not** compatible with E85 fuel.



Any reference to the left or right side of the vehicle is given from the driver's seat perspective.

4. Remove the cables from the battery with a 10mm wrench. The battery is located in the left front area of the engine compartment. Remove the battery hold down using a 10 mm socket wrench to loosen the two nuts shown with arrows. Then rotate the studs to disengage the lower hooks. Pull the battery out of the vehicle. This will allow clearance for the installation of new kit items. Now would be a good time to clean the plastic battery tray and metal underneath.

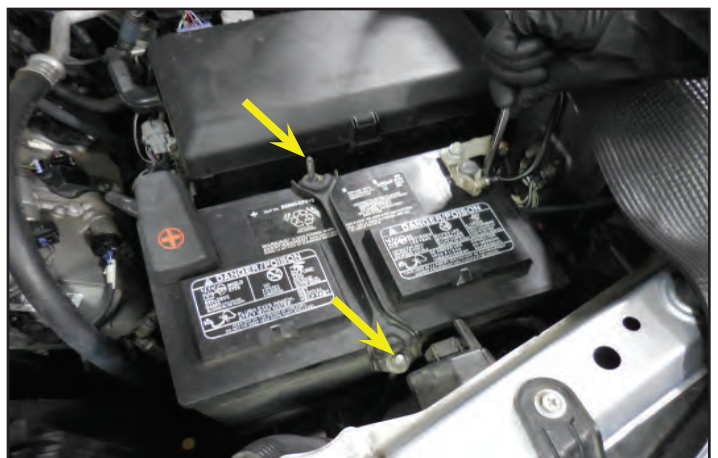

5. Remove the engine cover. Lift up at the front of the cover, and then pull away from the fire wall.



6. Relieve the fuel pressure by removing the fuel cap. Replace the fuel cap after pressure has been relieved. Wipe down the surface behind the fuel cap with denatured alcohol. Apply the provided "Use Premium Fuel Only" sticker to the area shown.



Section 2: Coolant Drainage

Allow the engine to cool down before draining any fluids.

7. Remove the skid plate. Use a 12 mm socket to remove the 5 bolts shown with red arrows (3 in back, and 2 up front). Use a 10 mm socket to remove an additional 3 bolts shown with yellow arrows.

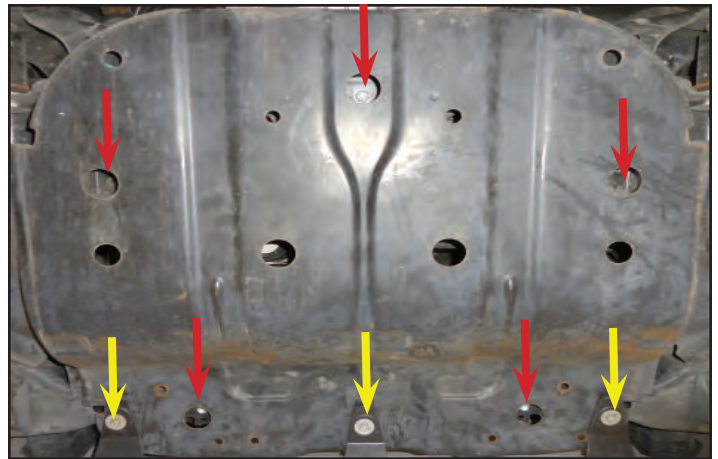

8. View of skid plate being removed.



9. Drain the coolant by opening the drain plug at the location shown with the arrow (lower left corner of the radiator). Have a clean pan, or bucket, ready for catching the fluid so that it may be reused.



10. Let the system drain completely before removing any hoses. This will take approximately 15 minutes to drain completely. Complete the next step to speed up this process.



11. Remove the radiator cap to help the coolant drain faster. Once the coolant has fully drained replace the cap, and tighten the drain plug.



12. Remove the clamps for the upper radiator hose where indicated with yellow arrows. Mark the end of the hose with a pen at the blue arrow area to indicate that this is the radiator side.

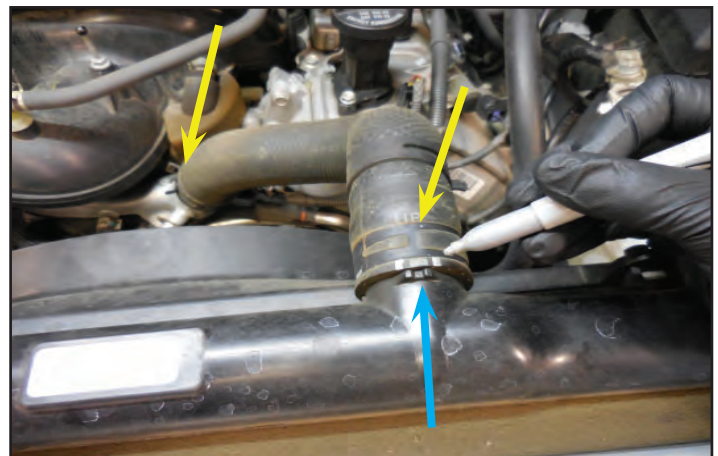

13. **Place some rags under the hose connection at the cross over to prevent coolant from getting on the belt/pulleys.** Remove the upper radiator hose.



14. Plug both coolant hose connections with clean towels to prevent anything from falling into them.



Section 3: Intake Manifold Removal

15. Use an 10 mm socket or nut driver to loosen the two hose clamps holding the air inlet tube in place.



16. Disconnect the vacuum and ventilation hoses at the locations shown. Slide the clamps back where necessary.



17. Remove the inlet hose assembly.



18. Disconnect the ventilation hose from the left side valve cover shown with the yellow arrow. Slide clamp upward. Then pull up on the hose.



19. Disconnect the other ventilation hose that is connected at the right valve cover shown with the arrow.



20. Remove the two mounting bolts at the locations shown with arrows.



21. Remove the hose assembly you just disconnected from the engine. Re-install the screws removed from the previous step back into their respective locations.



22. Disconnect the VSV hose shown with the arrow. This is located on the left side of the intake manifold. Slide the clamp back prior to pulling on the hose.



23. Disconnect the brake booster hose shown with the arrow. This is located at the left rear of the engine. Use pliers to slide the clamp back prior to pulling on the hose.

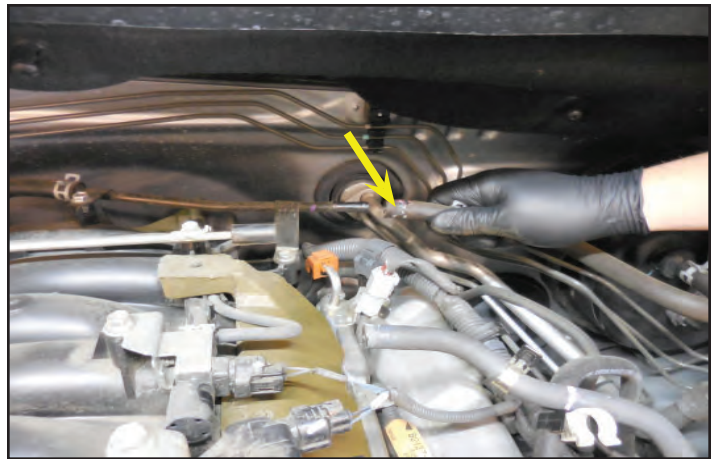

24. Disconnect the two VSV and ACIS electrical connections shown.



25. Remove the foam engine cover from the left side of the engine. Discard this part.



26. Remove the foam engine cover from the right side of the engine. Discard this part.



27. Disconnect the ventilation hose shown. Squeeze the clamp and pull back on the hose simultaneously.



28. Disconnect the electrical connection for the throttle body.



29. Disconnect the coolant line at the location shown. Use pliers to slide the clamp back.



30. Disconnect the second coolant hose shown with the arrow.

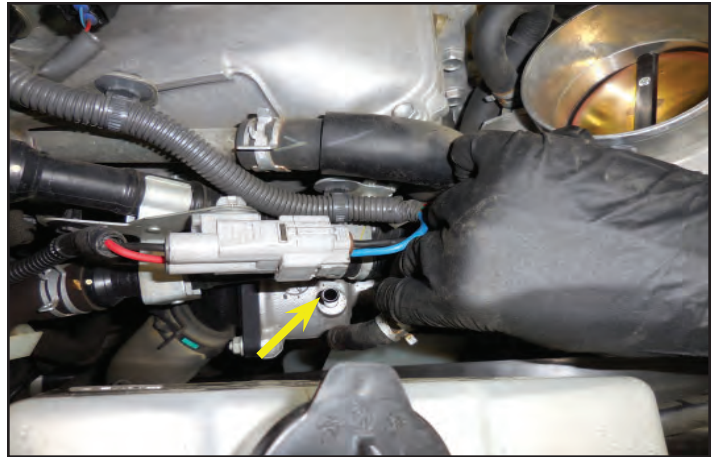

31. Use a 10 mm socket to remove the 4 bolts holding the throttle body in place. Save these bolts.



32. Remove the throttle body and hoses from the engine. These will be used on the new supercharger. Clean the sealing surfaces of the throttle body.



33. Note: This step applies only to 2014+ Tundra. Ignore this step if you have a 2007-13.

Remove and discard the bracket shown by first removing the nut shown with a yellow arrow using 10 mm socket wrench. Then remove the bolt shown with the red arrow. This is located on the right rear corner of the intake manifold.



34. At the right rear corner of the intake manifold use a pick to disengage the wire harness clip shown.



35. Use a 12 mm swivel socket to remove the 2 nuts and 8 bolts holding the manifold in place. Save these for use later.



36. Since it is hard to see the locations at the back of the manifold this photo was taken after it was removed. At the back of the manifold there are two brackets which hold a wiring harness with clip locations. The easiest way to release the manifold from the wiring harness is to remove the two bolts (red arrow locations) with 10mm heads that are holding the brackets to the manifold. These bolts and brackets will not be reused.



37. Remove the manifold, and set aside. Some parts from the manifold will be reused. Be careful not to damage the gaskets on the underside of the manifold when removing from the engine.



38. Once you have removed the manifold you can release the two brackets from the clamps by prying up at the arrow location with a small flat screwdriver.



39. Now use a shop towel with denatured alcohol, or some other non-petroleum based solvent to clean around the intake openings. Vacuum out any debris from around the intake ports.



40. Place tape over the ports to prevent anything from falling into them. **It is VERY important to not contaminate your work environment or allow any debris to fall into the exposed ports, or engine damage can occur.**



41. Use a breaker bar with a 14 mm socket and rotate the tensioner (located at the yellow arrow) counterclockwise to remove the OEM belt.



Section 4: Water Bypass Pipe, and Joint Replacement

Refer to the owners manual for proper lifting of vehicle, and wheel removal.

42. Raise the truck, and remove the left front wheel using a 22 mm socket.



43. With the front left wheel removed you will be able to remove the panel shown with the arrow for access to the A/C compressor.



44. Remove the 6 button rivets shown, and remove the panel.

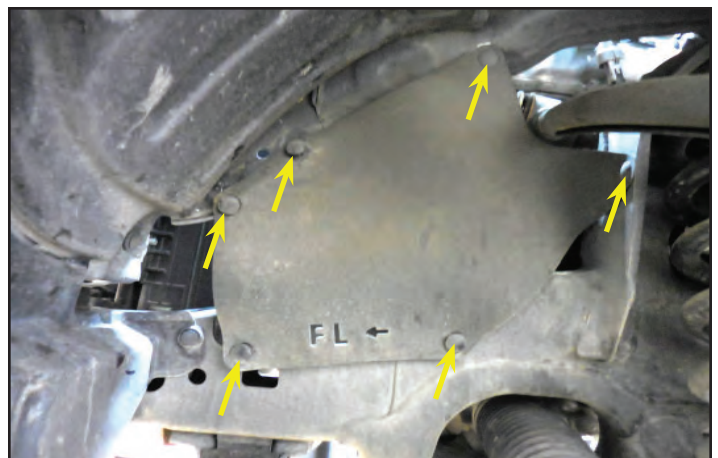

45. Remove the two nuts, and two bolts holding the A/C compressor to the engine. One of the nuts is obscured from view in this image. Slide the compressor away from the engine while keeping it on the 2 studs. You do not need to remove the compressor.

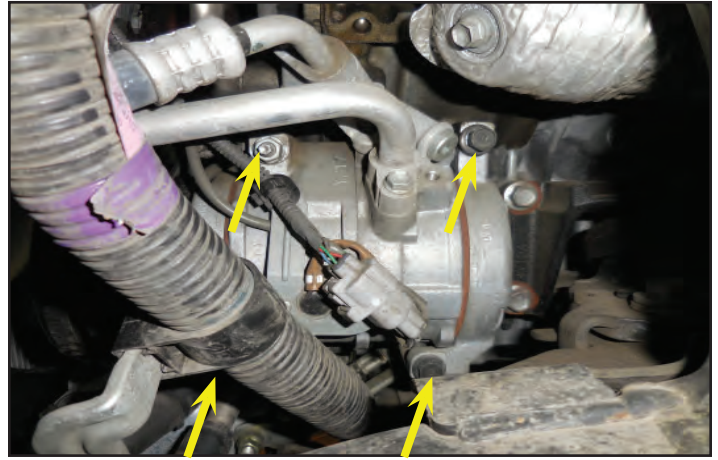

46. Remove the coolant hoses attached to the oil cooler shown with arrows in this image. Have a container ready to collect the coolant that will drain from these hoses. **Note: Picture is from the underside of the vehicle looking upward.**

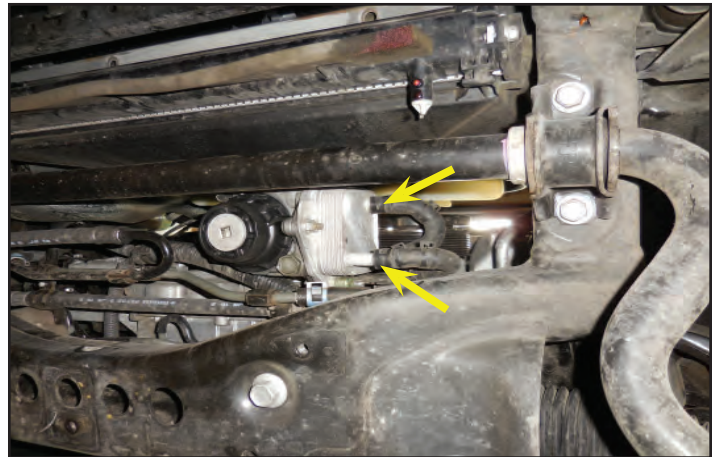

47. Here the coolant is being collected from the two coolant hoses disconnected in the last step. Pull down/straighten out the hoses to get all the coolant out.



48. Remove the hose shown after disconnecting the two clamps.



49. Disconnect the hose shown with the arrow.



50. Remove the bolt at the front of the coolant cross-over using a 10 mm socket. This will not be reused.

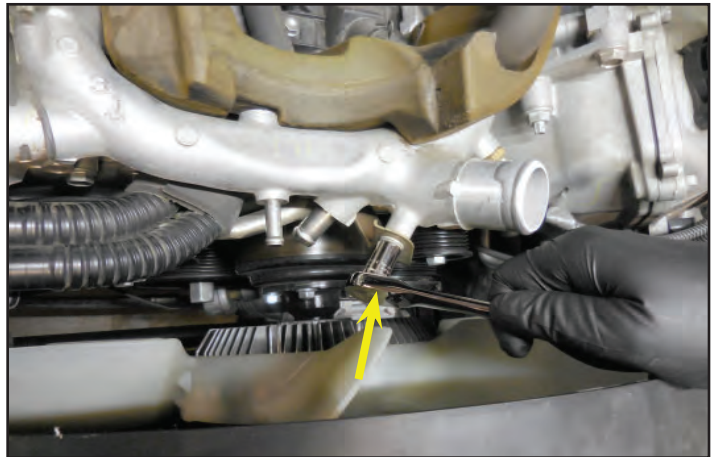

51. Remove two more bolts (shown with arrows) holding the bypass pipe assembly.

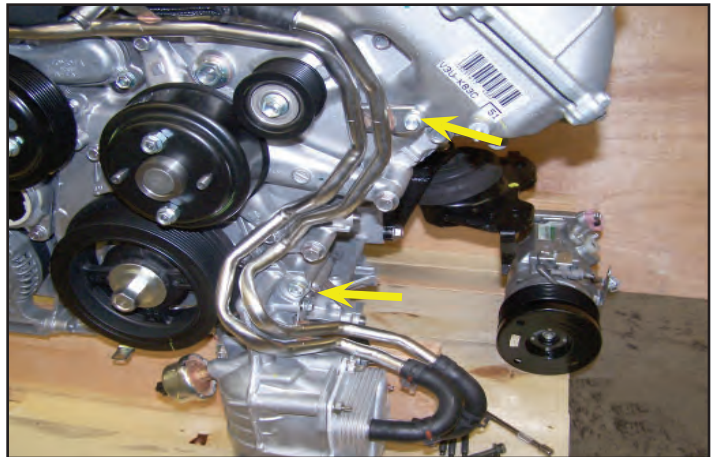

52. Disconnect the hose clamp at the arrow location and remove the hardline from the hose.

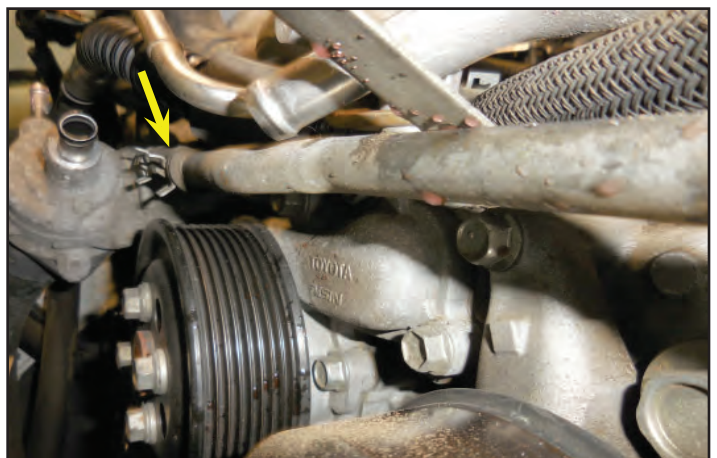

53. Remove the bypass pipe assembly shown. You may need to slide the A/C compressor further away to gain room to remove the tubes. Also make sure the hoses at the bottom of the tubes aren't getting caught on anything.



54. Here is a better view of the oil cooler hardlines. Only the hoses and clamps will be reused in a later step.



55. Discard the foam pieces at the front and rear of the valley cover shown here with arrows. Future pictures will show the rear foam still installed, but it should be removed.



56. Disconnect the coolant hose from the hardline where shown.



57. Unplug the water temperature sensor.



58. **Note: This step applies only to 2014+ Tundra. Ignore this step if you have a 2007-13.** Disconnect the two heater hoses where shown with yellow arrows. Rotate the clamps at the PCV valve (shown with red arrows) to the side to make more clearance for the supercharger.

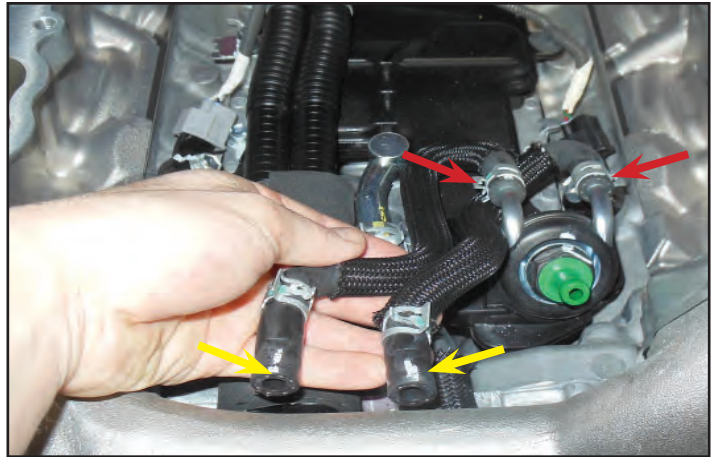

59. Remove the four nuts holding the coolant cross-over in place. Two are obscured from view in this image. The nuts and gaskets will be reused. Set the coolant cross-over aside.



60. Remove the ventilation hose shown. This will be replaced with a new provided hose in a later step.



61. Clean the mounting surfaces of the coolant cross-over with a clean rag. Ensure that the surface is clear of any debris, or old gasket material.



62. Inspect the OEM gaskets from the coolant cross-over, and install them in their original locations. Replace them if they are damaged. **Ensure that you have installed both gaskets.**



63. Remove the hose line shown with the arrow. This will be reinstalled later.



64. Apply a thin bead of coolant safe RTV to the surface of the supplied coolant cross-over.



65. Install the supplied coolant cross-over, and secure it with the OEM nuts. **Torque the nuts to 15 ft-lb. Ensure that the OEM gaskets are being reused to seal the coolant cross-over.**



66. Remove the section of hose from the OEM coolant cross-over. This will be reused.



67. **Supercharger shown installed for reference only.** Slide a long socket extension, or similar metal bar, into the coolant tube at the arrow location. We combined two 3/8" socket extensions to allow us to safely bend the tube without kinking it. Slowly bend the tube approximately 1" closer to the radiator and 1/2" down. This will provide the clearance for the throttle body.



68. Install the OEM coolant hose from two steps ago with clamps in the location shown with arrows.

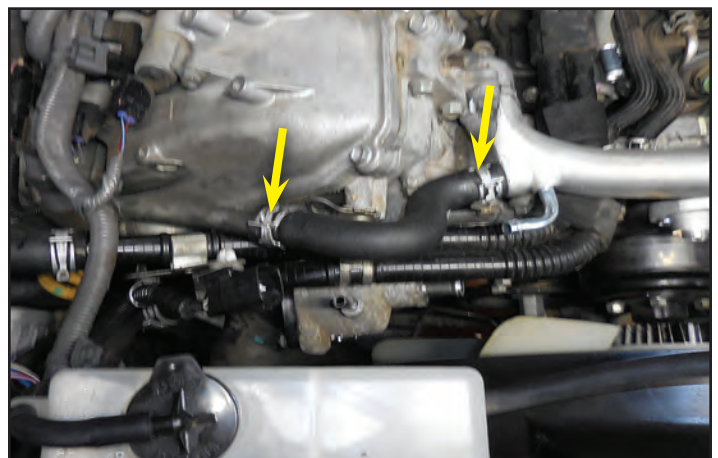

69. Remove the temperature sensor from the OEM coolant cross-over using a 3/4" wrench.



70. Ensure that the copper washer is in place before installing on the supplied coolant cross-over.



71. Install the OEM temperature sensor in the location shown with a 3/4" wrench. **Torque to 14 ft-lb.**



72. Use a 12 mm socket to remove the bolt shown with the blue arrow. Use a 14 mm socket to remove the two bolts shown with yellow arrows on the timing chain cover. Discard these three bolts.

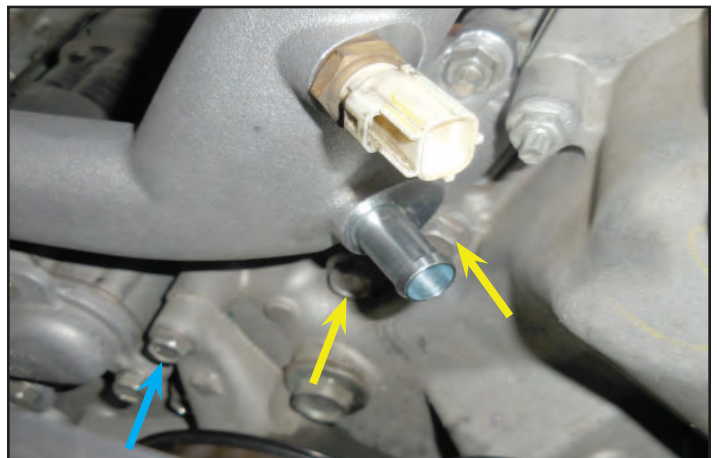

73. Install the provided bracket and bolts shown to the vacant holes from the last step.



74. **Torque the 6mm socket head bolt to 18 ft-lb, Torque the two 14 mm hex head bolts to 35 ft-lb.**



75. Reinstall the coolant hose (highlighted in red) at the location shown with the arrow. Route the hose through the idler pulley bracket as shown. Ensure that the clamp is rotated to the side to give clearance for the supercharger.



76. Remove the hose clamps, and hoses shown from the OEM throttle body. These will be reused, but in a different configuration.

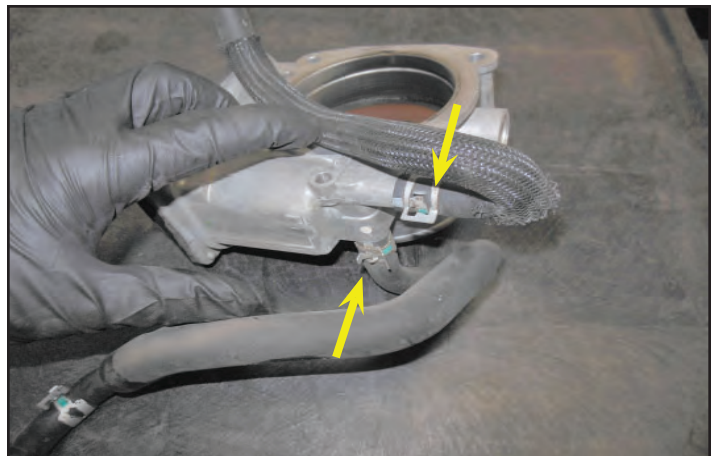

77. **Note: This step applies only to 2014+ Tundra. Ignore this step if you have a 2007-13.** Use the hose with the meshed covering from the throttle body just removed in the last step. This will get attached where shown with an arrow and cut as shown in the photo.

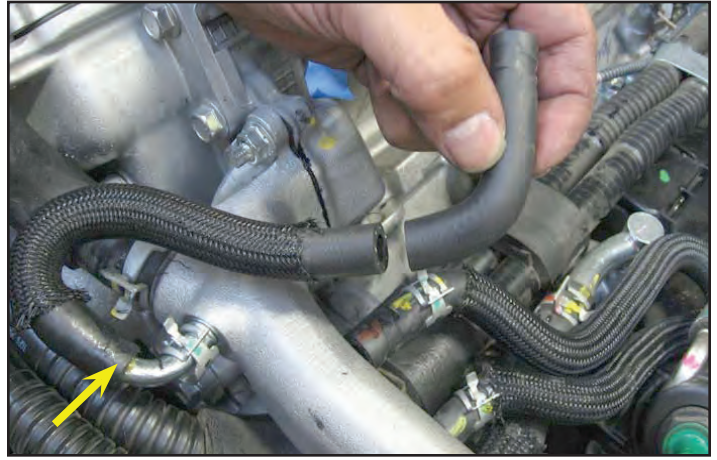

78. **Note: This step applies only to 2014+ Tundra. Ignore this step if you have a 2007-13.** Use a 5/16" hose mender and two clamps to connect the hose from last step to the right side hose going to the heated PCV valve (shown with an arrow).

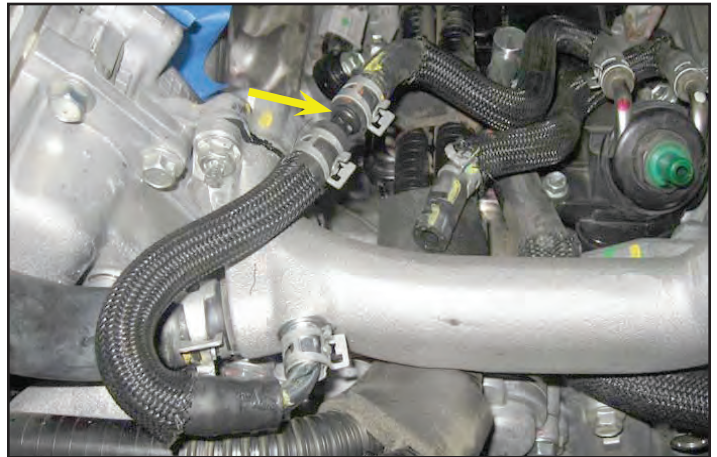

79. **Note: This step applies only to 2014+ Tundra. Ignore this step if you have a 2007-13.** Mark and cut the old hose from the throttle body that does not have mesh at the arrow location.



80. **Note: This step applies only to 2014+ Tundra. Ignore this step if you have a 2007-13.** Install the hose from the last step at the arrow location using the provided hose mender and two clamps as shown. The opposite end of this hose will connect to the throttle body with a clamp in a later step.



81. Install the idler pulley to the idler bracket using the provided M10 x 30 mm length bolt.

Torque the idler pulley bolt to 35 ft-lb.

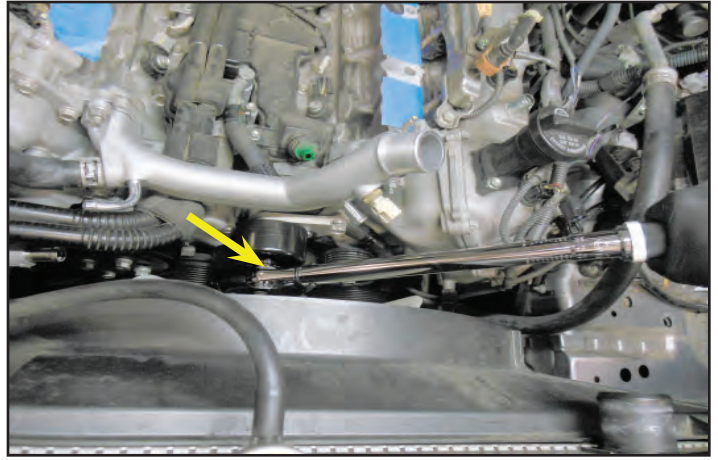

82. Unclip the wire harness from the stud shown. This is located at the front left side of the engine.

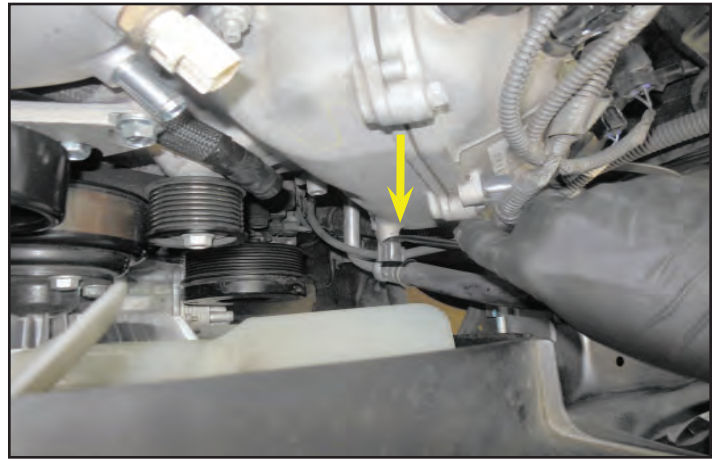

83. Use an E-6 (external Torx) socket to remove the stud shown. This will be discarded.

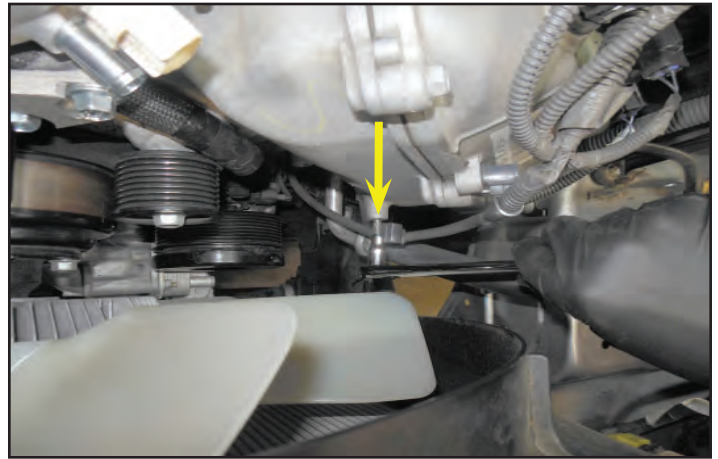

84. **Apply Loctite 242 to the provided M6 x 30 mm stud shown below** using a 3 mm Allen socket in the location where the stud from the last step was removed.

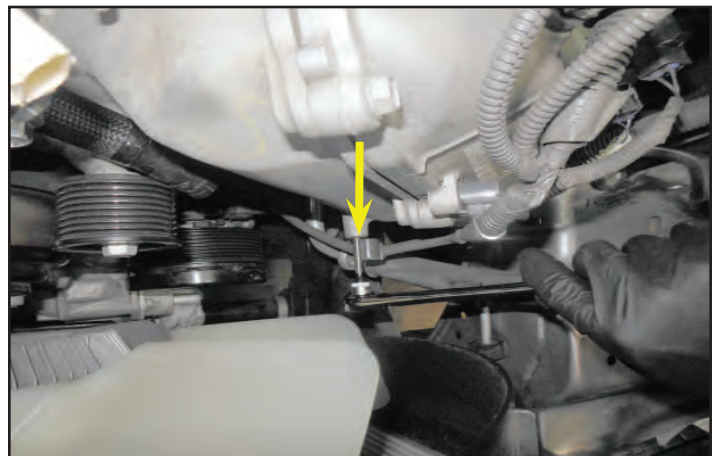
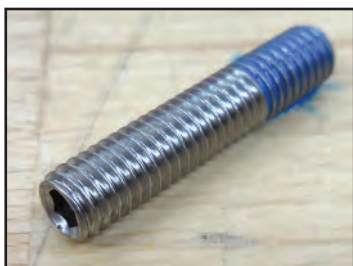

85. Connect provided oil cooler hard lines to the OEM hose locations (shown with arrows) using the OEM clamps. The tab on the hard lines should locate on the stud installed in the previous step.

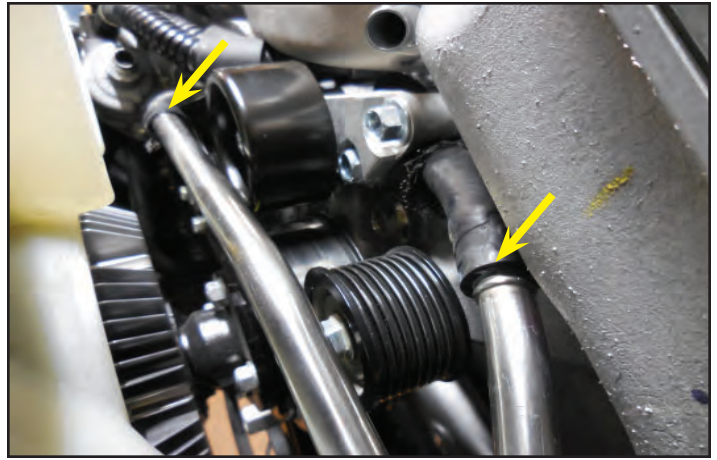

86. Connect the wiring harness for the temperature sensor.



87. Install the lower OEM hoses to the provided oil cooler hard coolant lines with the OEM clamps. The hoses connect the hardlines to the oil cooler. **Note: For reference this picture is looking upward from underneath the cooler.**



88. **Apply Loctite 242 to the provided serrated M6 nut shown below.** Ensure that the tab from the provided hard lines is attached at the stud location shown. Install the provided nut onto the stud where shown. **Torque to 108 in-lbs.**

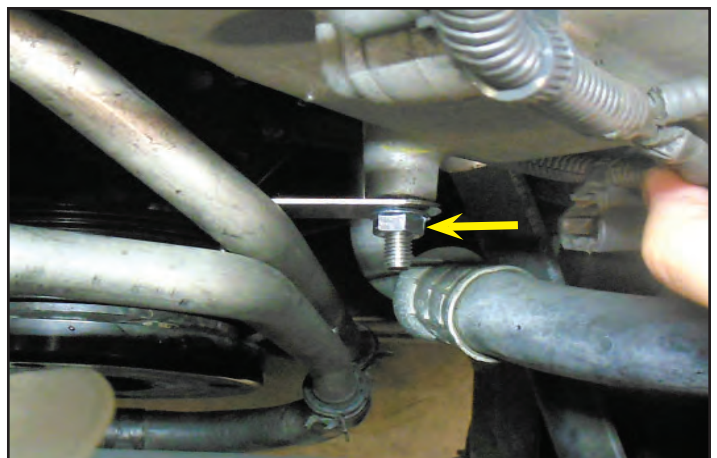
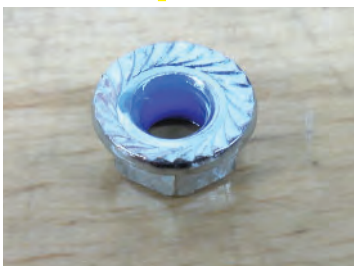

89. Reinstall the wire harness to the stud shown.

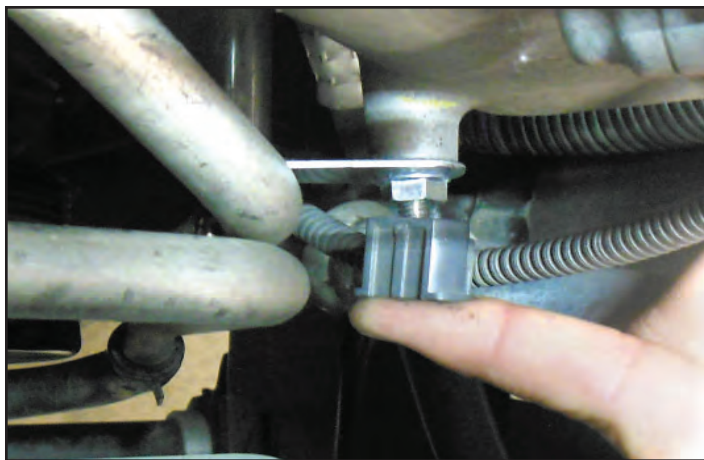

90. Reinstall the A/C compressor using the OEM nuts and bolts. **Torque all four locations to 18 ft-lbs.**



91. Reinstall the panel that covers the A/C compressor in the wheel well.



92. Reinstall and **torque the wheel to the specifications given in the owner's manual.**



Section 5: Fuel Injector Replacement

93. Disconnect the wiring harness from both fuel rails. This image shows the left side being disconnected.



94. Pull up on the rear fuel cross over line to disengage it from the retaining clips.



95. Wrap a towel around the fuel line connection shown. Disconnect the left side fuel line connection. Let the towel catch any fuel, then wrap the female fitting with a fresh towel. Slide back the orange safety clip then push in on the colored sides to allow the fitting to be removed.



96. Disconnect the right side fuel connection shown. Repeat the same process as in the previous step.



97. Use a 12 mm socket wrench to remove the four fuel rail mounts. **Note: The picture shows a front cross-over line installed. We temporarily installed this to contain the fuel. You can cap or plug the connections to achieve the same result.**

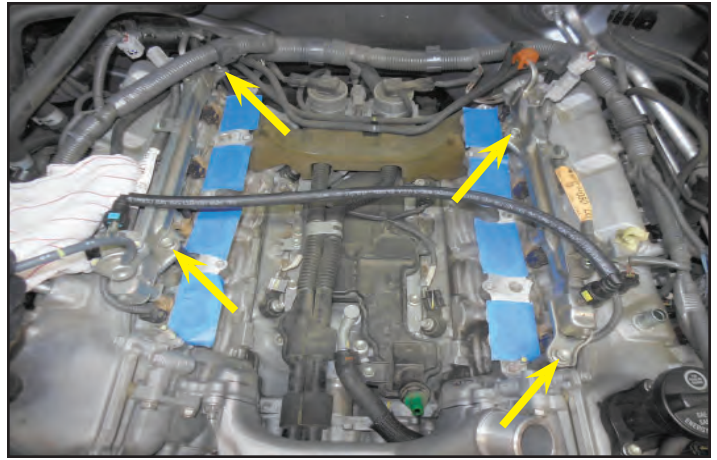

98. Remove the four fuel rail spacers.



99. Pull the fuel rails straight up with the injectors attached. **Important: Make sure the injectors stay installed in the fuel rails otherwise fuel will spill out. Take your time and slowly remove the assemblies.**



100. Use smooth needle nose pliers to carefully remove the eight seals from the fuel injector ports. These will be reused so take care when removing them. If you do not find the seal in the port it may be attached to the fuel injector. **Important: Be very careful to NOT knock any debris loose and down into the port. Take your time.**



101. Clean the seals with a bath of Simple Green or similar cleaning fluid. After they have soaked for a while wipe them off with a clean towel and inspect them for any damage. Replace any damaged seals.



102. Vacuum out the port locations to remove any loose debris. Also clean the ports with cotton swabs and Simple Green. Again, take your time, clean the ports thoroughly and make sure nothing falls down into them.



103. Tilt the fuel rail to one corner and place a plastic container under the corner. Remove the corner injector and let the fuel drain into the container. Repeat this process with another corner of the fuel rail to get more of the fuel out of the assembly. There is about 10 oz. of fuel in this assembly.



104. Take note as to the direction of each injector before you remove them and ensure the new injectors go in the same way. Remove each injector and unplug the electrical connector.



105. Clean the injector bores with a cotton swab and some Simple Green as shown.



106. Remove the new supplied injectors from the packages and examine the upper O-ring for any damage. Apply a small amount of the supplied lube to the O-ring.



107. Plug the electrical connector into the injector and insert the lubricated O-ring end of the injector into the fuel rail cup. Ensure that the tab from the injector fits between the two metal fingers as shown here with a yellow arrow. Also at this time apply a small amount of supplied lube to the base of each of the injectors where they contact the seals shown with the red arrow.



108. Reinstall the eight seals into the injector ports.

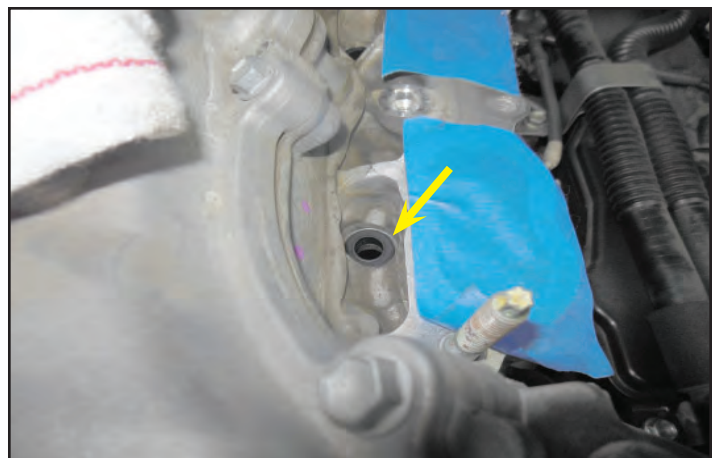

109. Install the new injector rail assembly into the eight seals installed in the last step. Loosely install the four fuel rail spacers and bolts. This will allow you some clearance when it comes to installing the supercharger. **Note: Install the bolts deep enough so that they prevent the spacers from lifting out of the grooves, but loose enough so that the rails can pivot side to side.**



110. Plug in the fuel injector electrical harness on the left and right hand sides.



111. Reconnect the fuel delivery lines to the left and right side of the fuel rail. **Make sure the fitting "clicks" into place and can NOT be pulled upwards. Then engage the safety clip by sliding it back into place.**

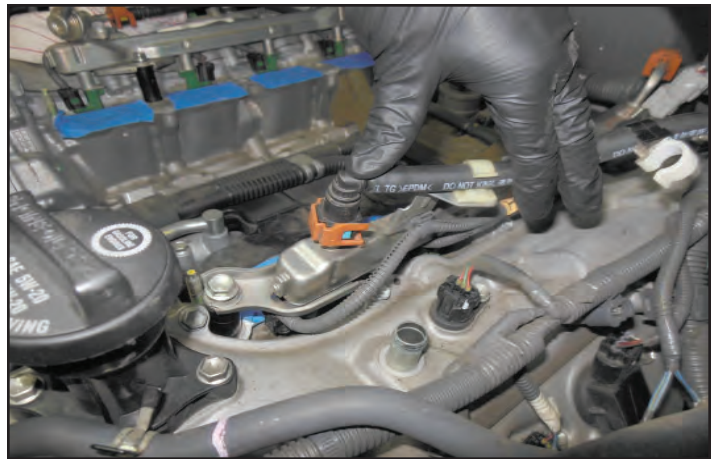

112. Install the crossover hoses back into their clips. Remove the foam if you haven't already done so.



Section 6: Air Box and Spark Plug Replacement

You may find it easier to remove the spark plugs on the right side with the entire airbox removed.

113. Remove the air box lid by disengaging the four clamps (two shown with yellow arrows). Unplug the mass airflow sensor (shown with a red arrow).



114. Detach the wire harness clip from the airbox lid using needle nose pliers, or a pick.



115. Remove the mass airflow (MAF) meter from the OEM air cleaner lid. **Discard the OEM air cleaner lid and the 2 OEM screws.** Install the MAF meter in the supplied air cleaner lid using the supplied #8x3/8" self tapping screws shown below.

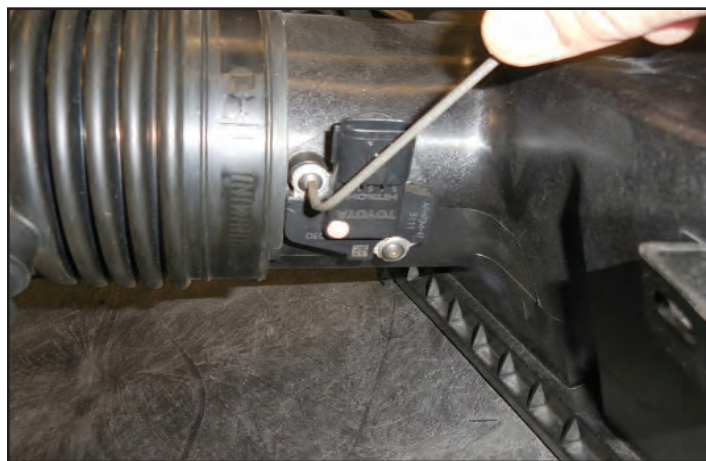

116. **Note: This step applies only to 2014+ Tundra. Ignore this step if you have a 2007-13.** Remove the air box bottom by removing the 2 bolts. Discard the two fasteners.

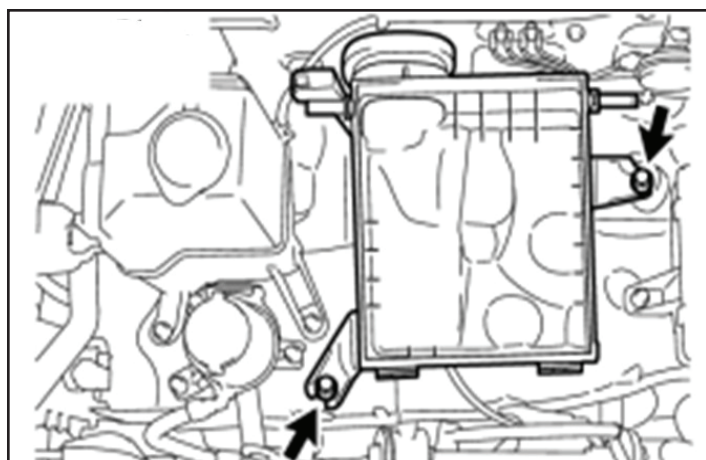

117. **Note: This step applies only to 2014+ Tundra. Ignore this step if you have a 2007-13.**

Use a flat blade screwdriver to unclip the air inlet tube from the OEM air box bottom. The air inlet tube will be attached to the provided air box bottom. The OEM air box bottom will be discarded.

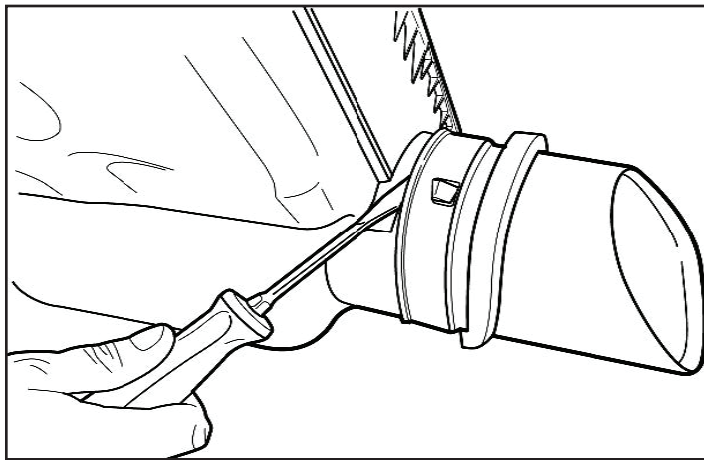

118. **Note: This step applies only to 2014+ Tundra. Ignore this step if you have a 2007-13.**

Ensure that the notch lines up with tab and press the air inlet tube onto the provided air box bottom until clips engage. Remove the grommet from your old air box bottom shown below and place it at the red arrow location in the photo to the right.



119. **Note: This step applies only to 2014+ Tundra. Ignore this step if you have a 2007-13.**

Install the new air box bottom using the bolts that are pre-installed. **Torque the bolts to 5.0 N-m (44 in-lb).**



120. Unplug all 8 coils, and remove the bolts with a 10 mm socket. The bolt has been removed from this coil pack from the location shown with an arrow.



121. Remove the coils by pulling them straight out. **Keep the coil packs in order so they are returned to their original location.**



122. Here is a coil pack with it's seal (shown with an arrow) attached. Clean these assemblies with a dry rag before reinstalling. Check the seals for damage and replace as necessary. **If the seal is not on the coil, then it should still be in the valve cover.**



123. Here are the 8 coil packs laid out in the order that they were located on the engine.



124. Use a 5/8" spark plug socket along with a universal joint and two extensions and a ratchet wrench to get to the rear plugs. The front plugs can be accessed with a long extension. Inspect the old plugs for any unusual signs. Plugs can reveal issues with the performance of an engine.



125. Place some anti-seize grease on the provided spark plug threads (Plug Gap: .032") Install the new spark plugs with the socket and extension, but without the ratchet wrench at first. This will allow you to feel the threads engage properly. Thread the spark plugs several full turns before using a ratchet wrench. **Torque the plugs to 13 ft-lbs.**

Reinstall the 8 coil packs in their original locations. **Torque the bolts securing the coil packs to 80 in-lbs.**



Section 7: Supercharger Preparation and Installation

126. Gather the provided PCV hose shown to the right. The longer one on the left is the OEM that was removed earlier. Remove the clamps from the OEM hose and place them on the provided hose.



127. **Note: This step applies only to 2007-13 Tundra. Ignore this step if you have a 2014+.** Remove 1/2" of foam from the provided vent hose. **Be careful not to cut into the hose when removing the foam.**

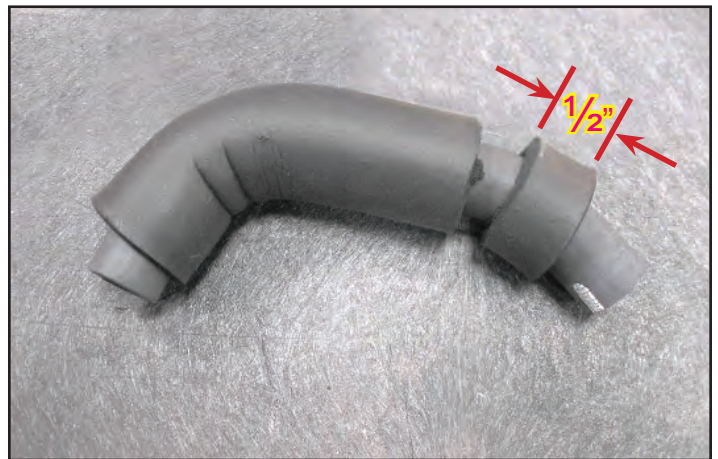

128. **Note: This step applies only to 2007-13 Tundra. Ignore this step if you have a 2014+.** Remove 1/2" from the end of the hose on the same side you removed the foam from the last step.

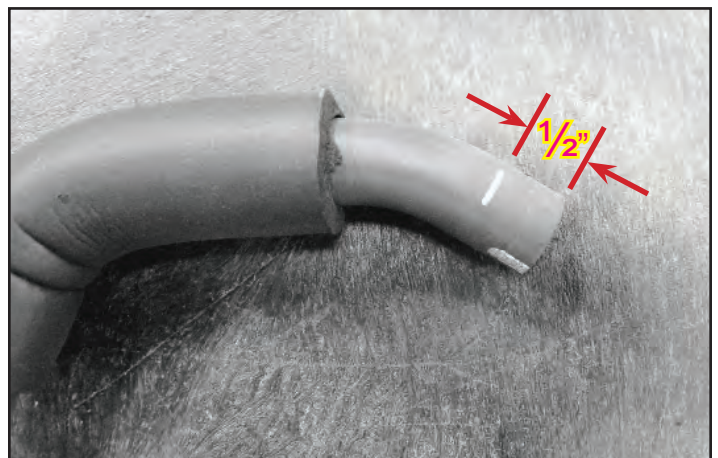

129. Attach the OEM spring clamp to the end of the provided PCV hose, and install at the location shown with an arrow.

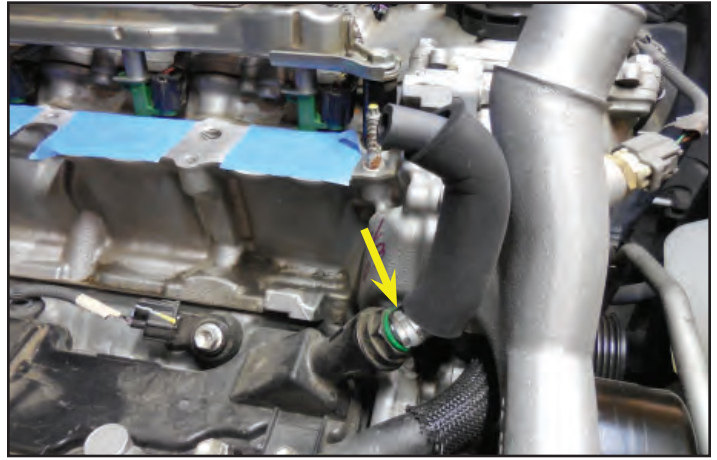

130. **Discard the rear foam engine cover (shown with an arrow).** Make sure everything is clear of the engine valley. Remove the tape covering the intake ports.

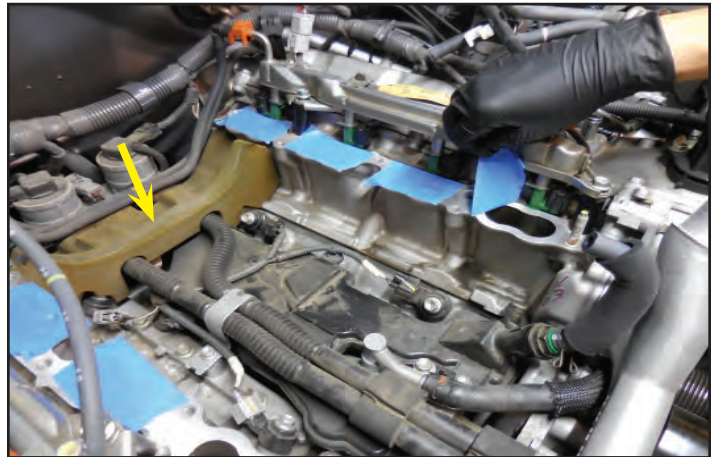

131. Spray Tri-Flow (or equivalent PTFE based lubricant) on a clean towel. Wipe the intake surfaces with Tri-flow on a clean towel.

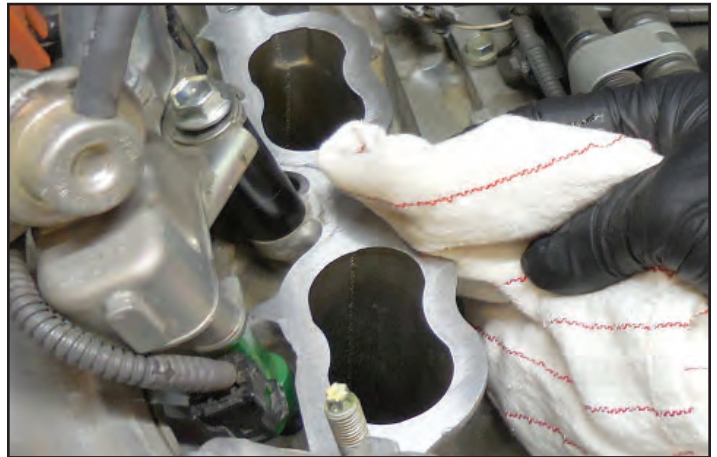

132. Remove the lid bolts and the lid.



133. You can install some long M8 bolts into the 4 arrow locations around the perimeter of the supercharger to enable installation.

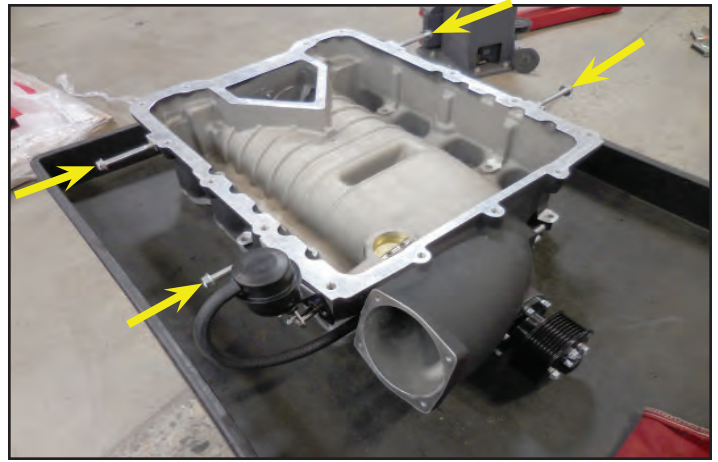

134. Remove the left and right OEM intake gaskets from the manifold. Clean and inspect the gaskets. Replace if damaged. Apply a light coat of clean motor oil to the gaskets.



135. Flip the supercharger upside down on a suitable clean soft surface and install the OEM gaskets into the grooves. Ensure that the gaskets are fully engaged in all the grooves.



136. Apply Loctite 242 to the 4 provided M8x75mm bolts and the 4 OEM manifold bolts and two OEM nuts.



137. With the help of a few friends, place the supercharger assembly onto the engine. **Be careful not to damage the gaskets on the underside of the supercharger.** Lightly install the 4 longer bolts from the last step in the arrow locations.

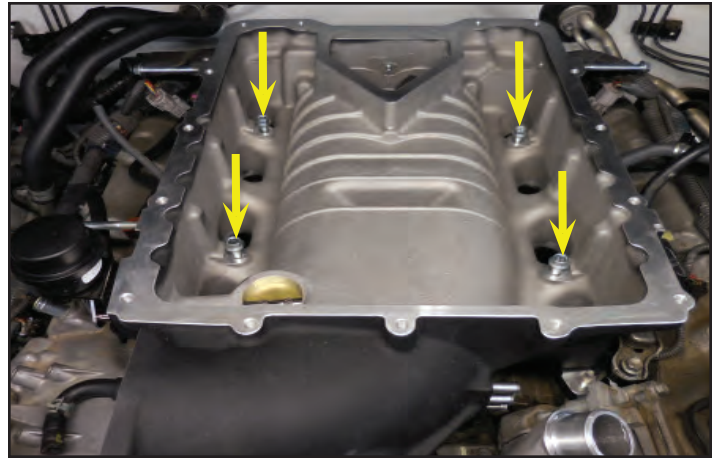

138. Install the OE bolts and nuts to secure the supercharger in place. Use a telescoping magnet to drop the bolts in place. The nut goes at the front stud on both sides. There are 3 more of these locations on the other side.

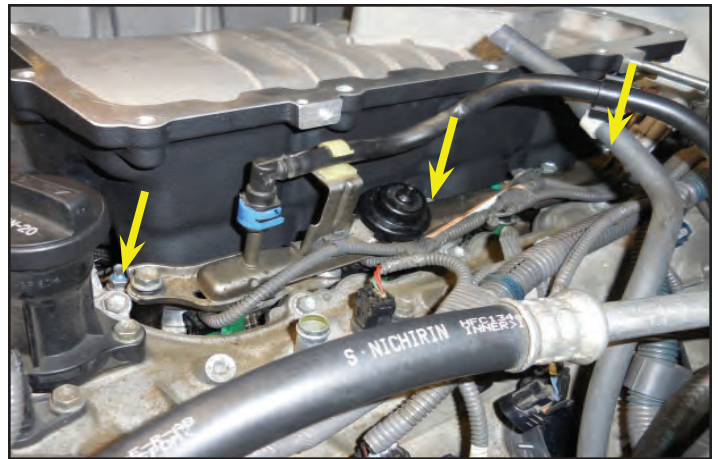

139. **Note: The boost reference port location is shown at the arrow. You can replace the provided plug at this location with a barbed connector to allow the installation of a boost gauge.**

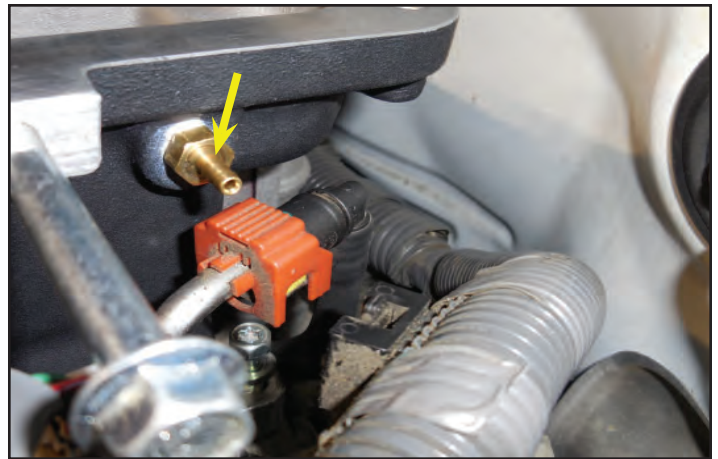

140. **Follow the torque sequence given in the diagram at the back of this manual. Torque the manifold bolts to 15 ft-lbs. Also at this time torque the 4 fuel rail bolts to 15 ft-lbs.**



141. Apply Loctite 242 to the 13 M8x30mm, and 2 M8x50mm lid bolts that were removed earlier.



142. Pre-install the 4 M8x30mm bolts at the back of the supercharger housing. You only need to engage a few threads at this time.



143. Use rubbing alcohol to clean the area on the lid where the two Magnuson badges will be installed.



144. Apply Loctite 242 to the four M4x8mm button head badge bolts.



145. Peel the covering off the adhesive backs of the two badges before you secure them with the bolts from the last step.



146. Slide the rear of the lid under the 4 pre-installed M8x30mm bolts.



147. **Torque the lid bolts to 18 ft-lbs. following the sequence from the diagram at the back of this manual.**



Section 8: Serpentine Belt, Throttle Body and Hose Installation

148. Install the provided belt following the routing diagram at the back of this manual. Rotate the tensioner counterclockwise as you did before to allow the slack necessary to install the belt over the supercharger pulley as the final belt location. Ensure that the belt is aligned over all the pulleys.



149. Cut the supplied $\frac{1}{2}$ " coolant hose to 3" and $2\frac{3}{4}$ " lengths and install on the supplied "J" shaped hard line with the provided hose clamps.

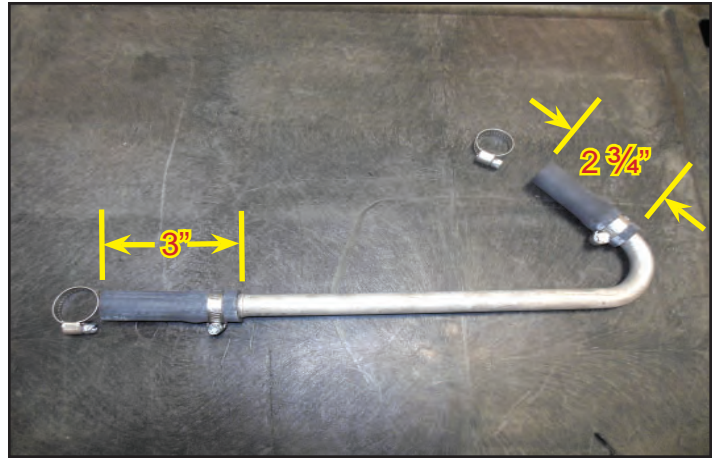

150. Install the "J" shaped hard line from the last step in the location shown with the provided hose clamps. Make sure the hardline has proper clearance to surrounding components. This line is easier to install to the straight side first.

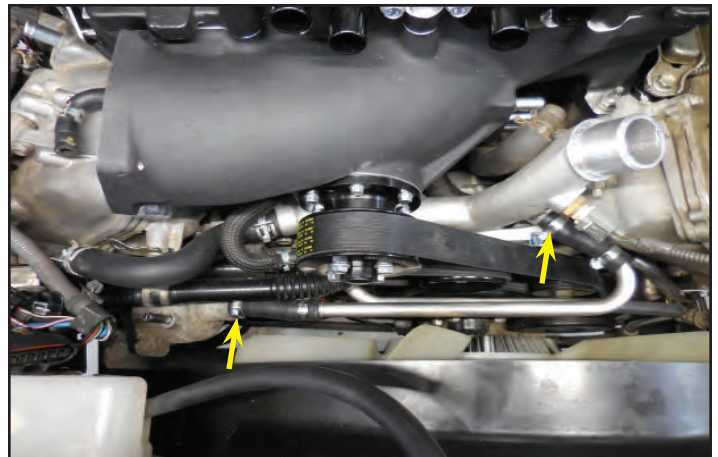

151. Apply Loctite 242 to the OEM throttle body bolts.



152. Gather the provided throttle body gasket shown.

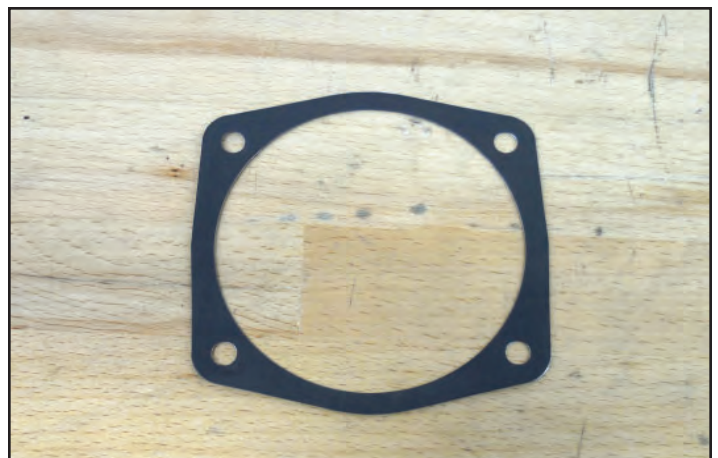

153. **Install the throttle body gasket from the last step** at the supercharger inlet followed by the throttle body using the original orientation shown with the 4 bolts from two steps ago. Ensure that the throttle body does not interfere with other hose connections while installing. **Torque the 4 bolts to 108 in-lbs.**



154. Plug in the throttle body connection at the arrow.

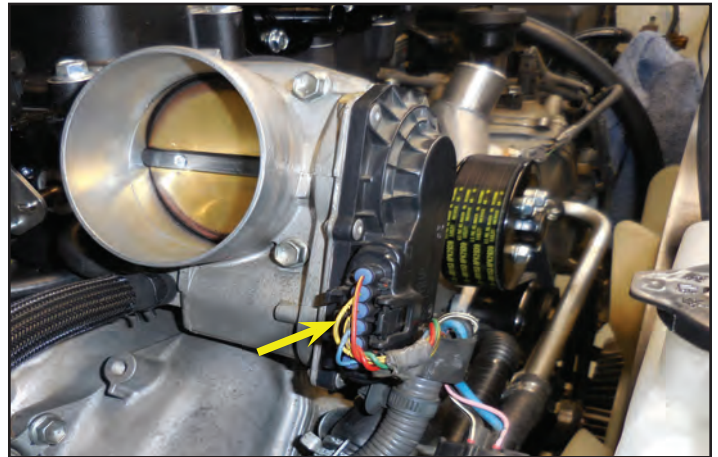

155. Install the coolant hose that was routed under the supercharger earlier to the rear facing connection of the throttle body (arrow location) and secure with the OEM spring clamp. Ensure that the hose isn't pinched under the supercharger.

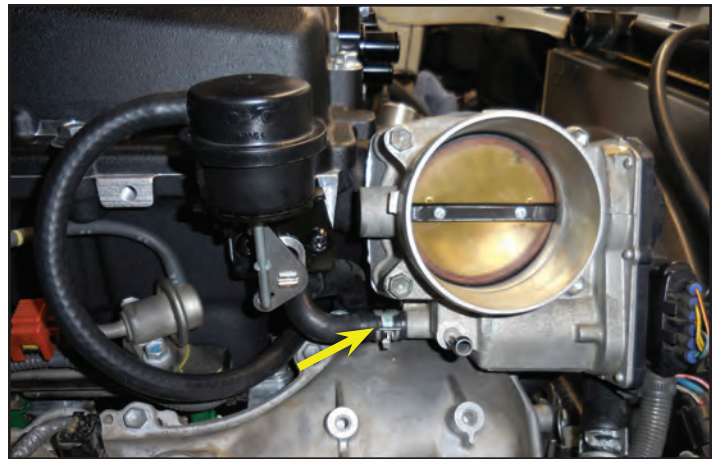

156. Install the provided spring clamps on the 3/8" Ø by 13" long coolant hose as shown.



157. Connect one end of the hose from the last step to the arrow location of the throttle body and secure with one of the spring clamps.

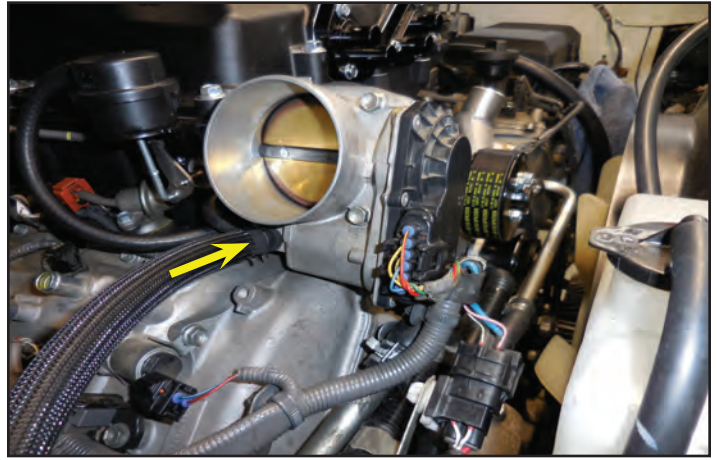

158. Connect the opposite end of the hose from the last step at the arrow location and secure with an OEM spring clamp.



159. Install the provided air inlet tube to the throttle body with the provided worm drive clamp.



160. Insert the provided 1/8" barbed connector at the arrow location and install the hose from the fuel regulator to this location.



161. Install the provided 1/2" Tee at the arrow location. Install the provided 1/2" ID X 27" long EVAP hose to the Tee fitting using an OEM spring clamp.

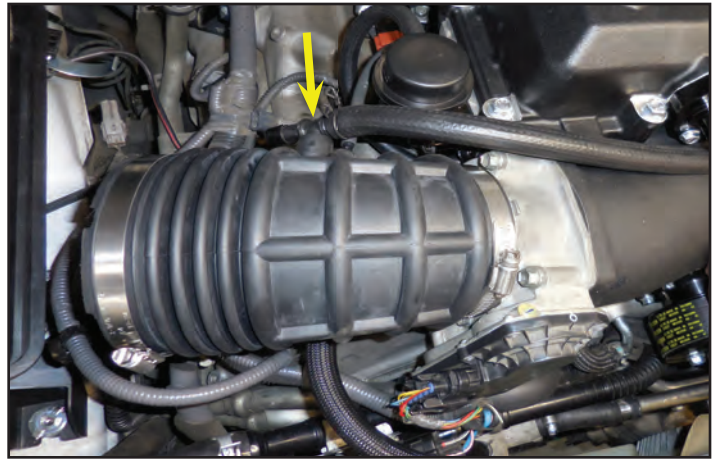

162. Install the 30" x 3/4" Ø OD mesh to the 27" hose and secure the opposite end to the left valve cover at the arrow location and secure with an OEM spring clamp.



163. Gather the hose assembly that was removed earlier and remove the section that has no foam covering (arrow location).



164. Cut the hose that was removed in the last step just before the bend as shown here. The shorter section will be saved for the next step.



165. Install the section of hose that was cut in the last step between the Tee and the right valve cover vent tube as shown here at the arrows and secure with two OEM spring clamps.

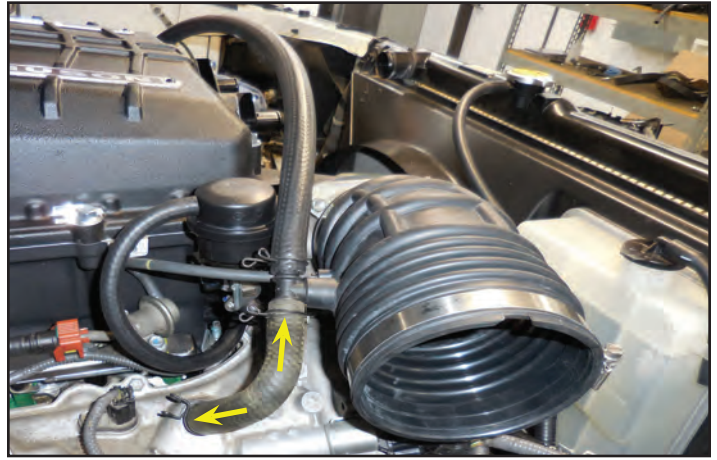

166. Install the provided filter into the airbox.



167. Insert the supplied airbox lid at the arrow location at the air inlet. Ensure that the MAF sensor is installed with the provided #8x3/8" screws.



168. Secure the airbox lid with the 4 spring clips.



169. Secure the inlet with the provided hose worm drive clamp.



170. Plug in the MAF electrical connection at the yellow arrow and secure the wire to the lid at the green arrow.



171. Remove the VSV and hose from the OEM intake manifold. Save the bolt (green arrow) for use in a later step. The hose will be used in another location but can be left on the VSV for now.

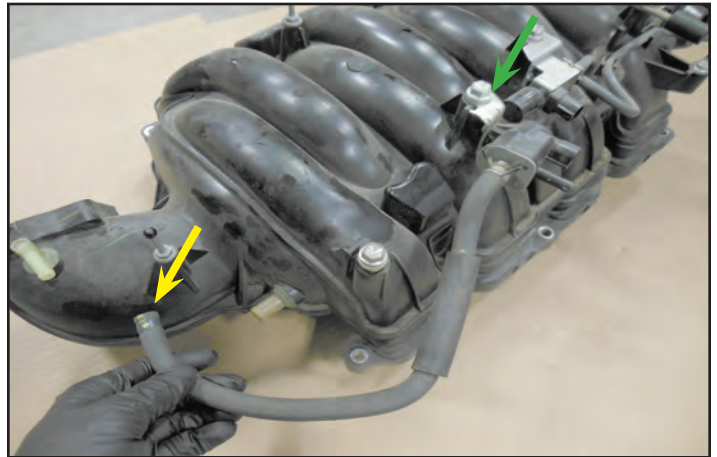

172. Remove the bracket from the VSV with a Phillips head screwdriver. The bracket and screw will not be reused.



173. Gather the provided M6x10mm button head bolt and star washer. Apply Loctite 242 to the bolt as shown.

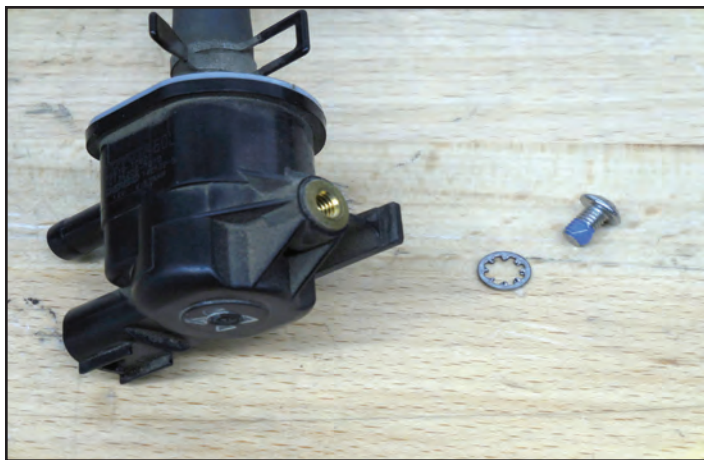

174. Secure the provided reservoir with the 3 provided bolts at the yellow arrows into the provided bracket. Install VSV at the green arrow location with the star washer and button head bolt from the last step.

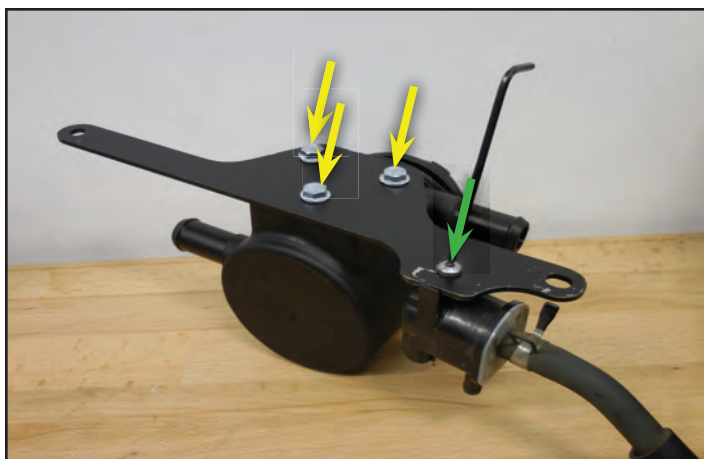

175. Apply Loctite 242 to the two provided M8x16mm bolts shown below and use them to install the bracket from the last step into the supercharger at the arrow locations. Torque these bolts to 108 in-lbs.



176. Cut approximately 2" from the hose on the VSV valve.



177. Connect the VSV hose to the bottom air tube on the supercharger inlet (arrow location).



178. Cut approximately 4" from the hose that goes to the other side of the VSV valve.



179. Connect the hose from the last step to the VSV valve (arrow location) and secure with the OEM hose clamp.



180. Secure the PCV hose onto the middle air tube on the supercharger at the arrow location and secure with the OEM spring clamp.



181. Gather the 26" section of 11/32" brake booster hose and install one side at the top barb of the supercharger and secure with an OEM clamp. Install the opposite side to the brake booster after routing it as shown. Ensure that you have secured the brake booster side with an OEM clamp as well.



182. Plug the VSV connector at the red arrow location. Wrap the ACIS connector with electrical tape and secure it to the electrical harness at the yellow arrow with a cable tie.



183. Reinstall the top radiator hose in its original orientation. This is the orientation that will provide the most clearance for the hoses that will follow.



Section 9: Intercooler System Installation

184. **Note: This step applies only to 2014+ Tundra. Ignore this step if you have a 2007-13.** Remove the 4 bolts at the arrow locations.



185. **Note: This step applies only to 2014+ Tundra. Ignore this step if you have a 2007-13.**

Disengage the clip rivet fastener at the arrow location near the headlight by pulling up on the center first with a small screwdriver, and then pull up on the outside of the clip rivet. Repeat the process on the other side.



186. **Note: This step applies only to 2014+ Tundra. Ignore this step if you have a 2007-13.**

This photo was taken from the left side gap above the front bumper, and shows the tabs behind the radiator grille. There are two tabs on each side of the grille. The tab towards the rear (shown with the yellow arrow) must be pushed downwards. The tab towards the front (shown with a red arrow) must be pushed upwards. After these tabs are released on both sides you can pull the grille forward to remove it.

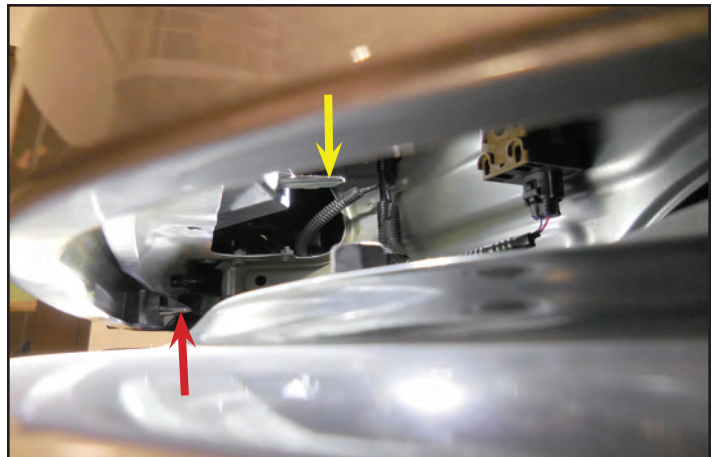

187. **Note: This step applies only to 2014+ Tundra. Ignore this step if you have a 2007-13.**

Here you can see the grille removed and the two tabs that were disengaged in the last step.



188. **Note: This step applies only to 2014+ Tundra. Ignore this step if you have a 2007-13.**

Remove the nuts at the 6 arrow locations for the lower grille support. Now remove the grille support.

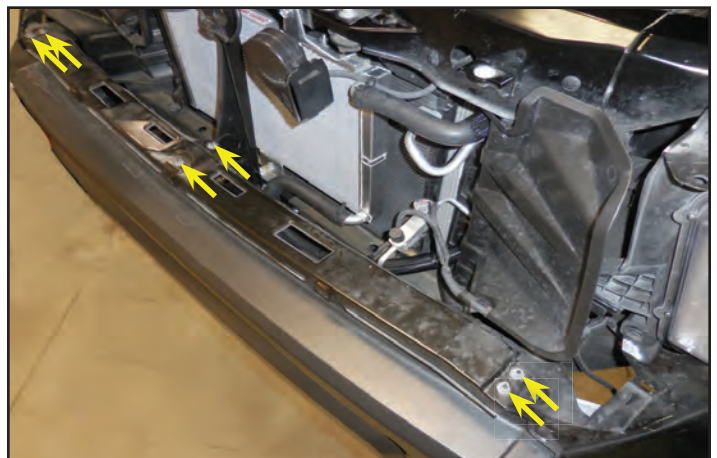

189. Unplug the electrical connection for the horns. Remove the bolt holding the horns in place and set the horns aside for reinstallation at a later step.



190. Remove the three rivets shown with arrows. Twist the head with a Phillips screwdriver to disengage it, then pull the rivet body out. Newer vehicles will have slightly different fasteners.

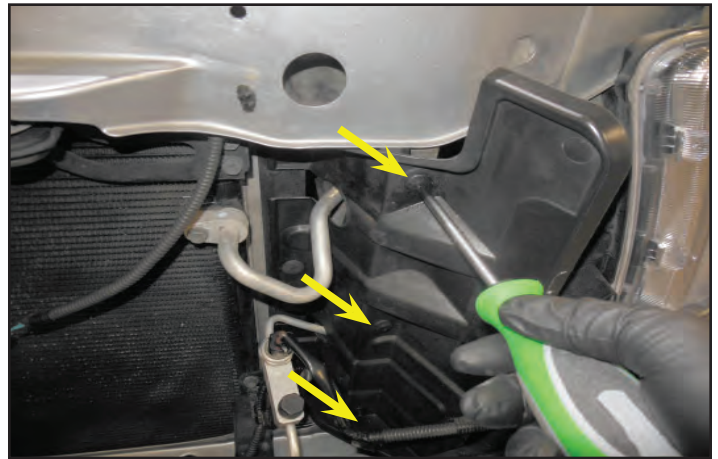

191. Disconnect the plastic clip holding the wiring assembly to the plastic shroud (shown with a yellow arrow). Unplug the A/C connector shown with a red arrow.



192. Unplug the ambient air temperature connector shown.

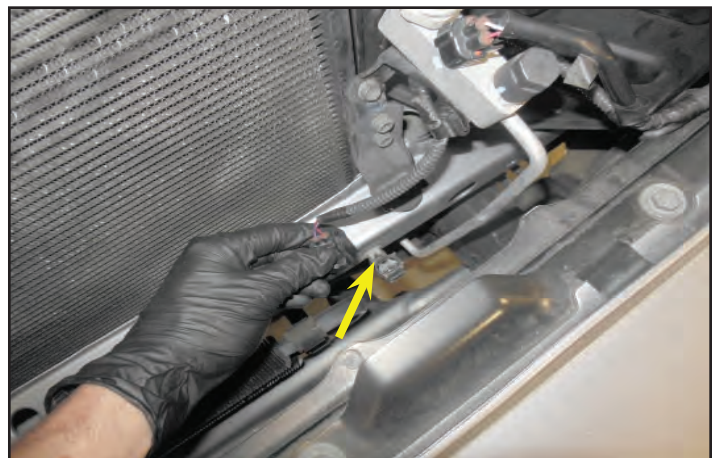

193. Disconnect the plastic clip holding the wiring assembly to the metal frame. The wire assembly should now be free. Move it temporarily toward the left side headlight.



194. Remove the “tree” rivets holding the left side radiator shroud in place. The rivets are easier to remove if you push the back side of them through.

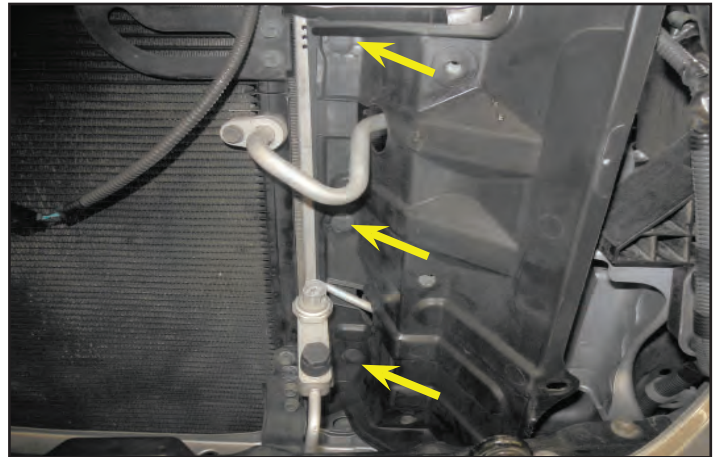

195. Remove the left side radiator shroud. This will be modified and reinstalled later.



196. Mark and remove areas highlighted in yellow on the radiator shroud from the last step. You can drill out the corners then use a Dremel or razor to cut out the rest. Remove all sharp edges. Reinstall the modified radiator deflector in it's original location with the OEM rivets.

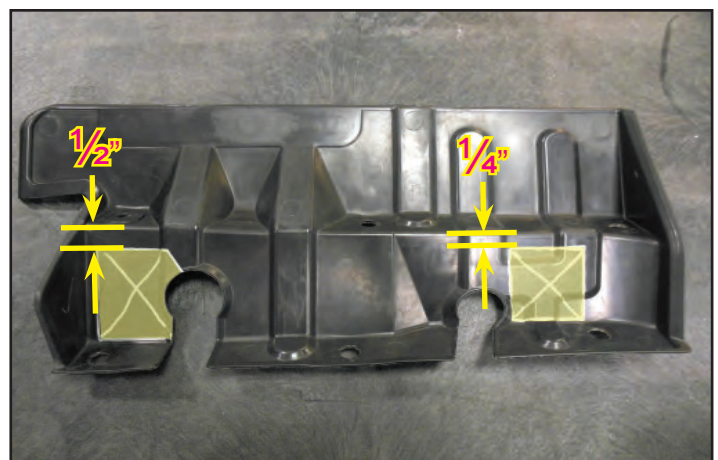

197. Install the provided LTR/Pump bracket behind the center vertical brace, and in front of the radiator.



198. Install the provided rectangular bodied M8 nuts behind the lower radiator cross beam. These will be used with a bolt to secure the LTR/Pump bracket. There is another location at the left side of the bracket for the other nut and bolt.



199. Install the M8x20mm bolt through the front while holding the rectangular bodied nut shown in the previous step and tighten it in place. Repeat this process on the left side of the bracket.



200. **Note: This step applies only to 2014+ Tundra. Ignore this step if you have a 2007-13.** Remove the plastic cap at the bolt location on the hood latch bracket at the arrow location.



201. **Note: This step applies only to 2014+ Tundra. Ignore this step if you have a 2007-13.** Make alignment marks between the latch assembly and the crossbrace to allow proper relocation prior to removal. Remove the 3 bolts holding the latch assembly at the arrow locations. Temporarily move the latch assembly out of the way.

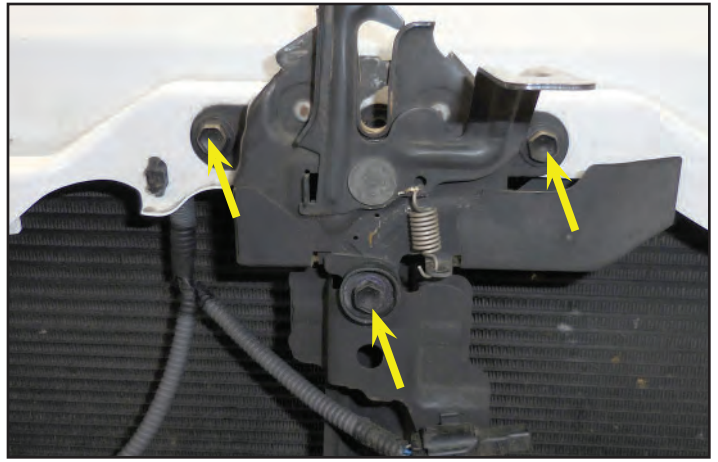

202. **Note: This step applies only to 2014+ Tundra. Ignore this step if you have a 2007-13.** Remove the bolt at the top of the hood latch support. This will allow you to pull the top section of the support away from the radiator to allow installation of the Low Temperature Radiator in the next steps.



203. Gather the Low Temperature Radiator (LTR). The LTR is shown with its mounting brackets.

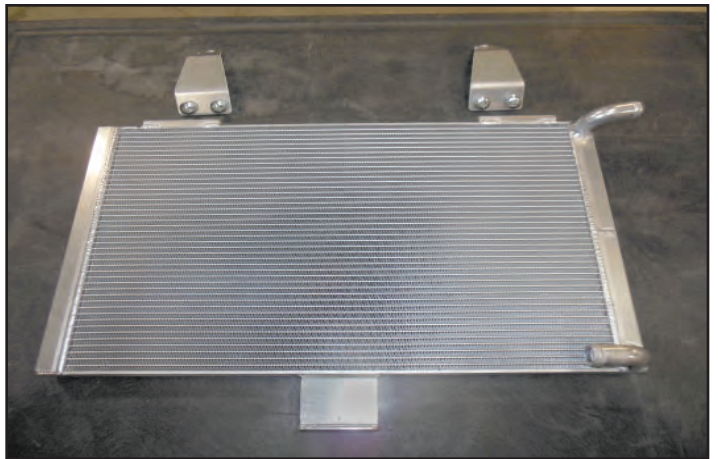

204. Gather the upper mounting brackets along with the nuts and shoulder bolts shown. These will be attached to the LTR in a later step. Insert the bolts from below and attach the nuts from above as shown on the bracket to the left in this photo. Keep these bolts loose for installation in a later step.



205. Slide the LTR in front of the A/C condenser and behind the hood latch support. Be careful not to damage the cooling fins on the condenser, or the LTR. Align the two holes in the lower bracket with the studs from the bracket attached behind the center vertical brace.

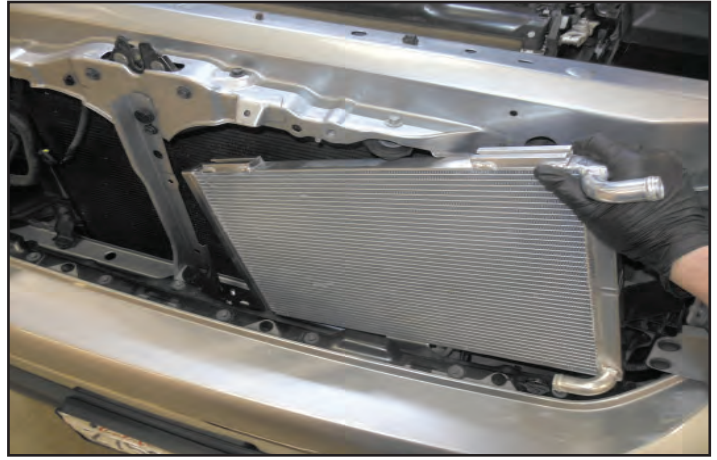

206. **Note: This step applies only to 2014+ Tundra. Ignore this step if you have a 2007-13.** You can reinstall vertical latch support and latch assembly. **Ensure that you align the latch assembly to the marks that you made previously before tightening.**



207. Slide the bracket with nuts and bolts attached loosely into the channels on top of the intercooler.



208. Align the bracket so its hole lines up with the threaded hole used to mount the horns (shown with an arrow). Tighten the nuts to maintain this alignment. Repeat this on the opposite side of the LTR.



209. Fasten the lower bracket of the LTR to the two studs from the bracket behind the center vertical brace using two nuts.

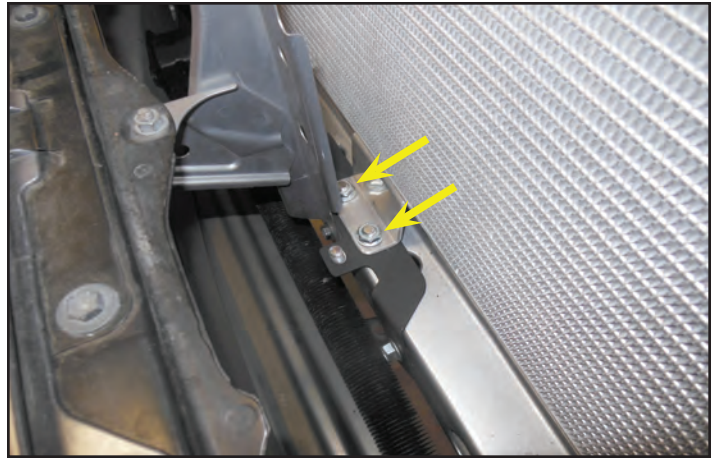

210. Re-attach the two horns at their original locations using the provided M8 x 20 mm bolts. Plug in the electrical connections to both horns.

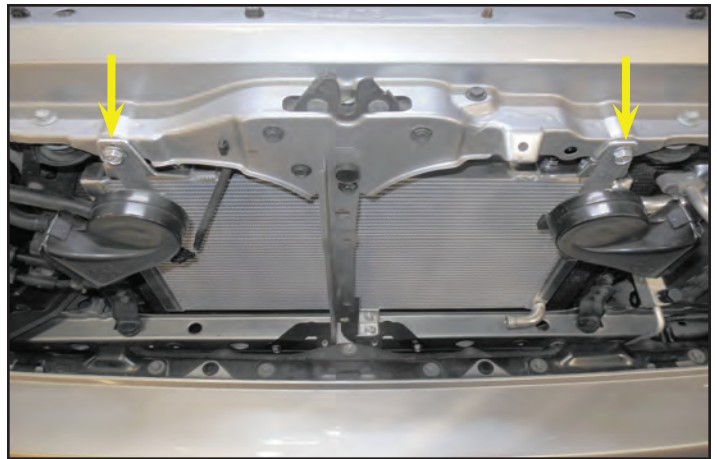

211. Pre-install the electrical wiring adaptor to the provided pump (green arrow) if applicable. Wrap the supplied Adel clamp around the provided pump and install it at the yellow arrow location with a provided nut.



212. Mark the provided hose at 2.25" from the outside edge as shown here and cut at the marked line.

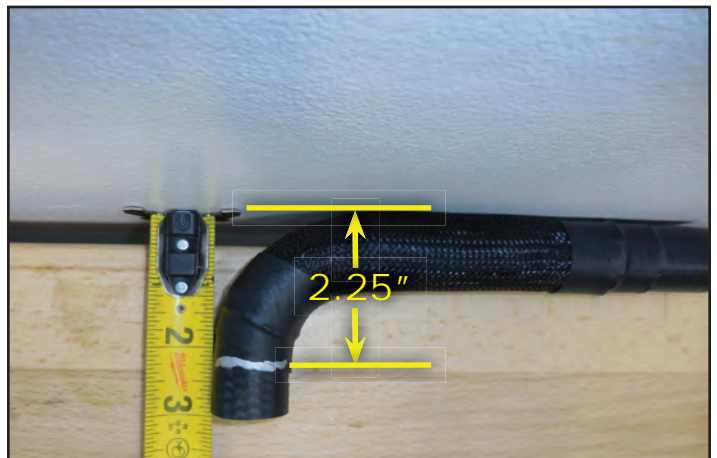

213. Install the hose from the last step between the lower LTR hose barb and the output of the pump and secure them with the provided spring clamps. You will need to rotate the pump in a direction that allows the hose to clear the LTR fins by approximately 0.25" as shown.

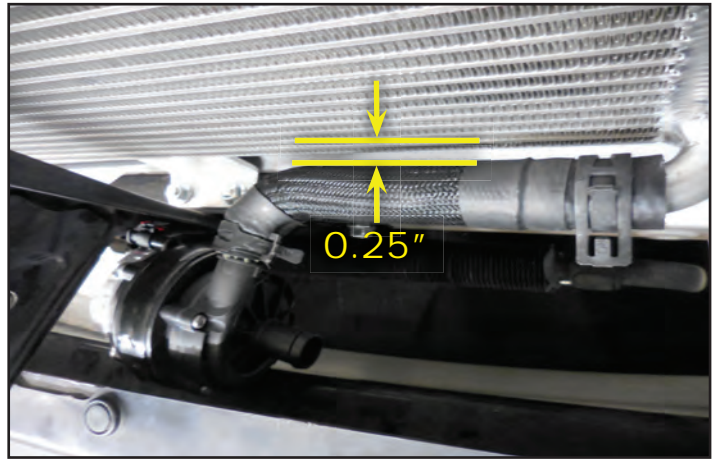

214. Gather the 3/4" hose assembly with the "U" shaped end and connect it to the back of the reservoir using a provided spring clamp.



215. Route the hose from the last step through the lower slot that was cut in the plastic side panel.



216. Trim the end of the hose from the last step just before the bend as shown here.



217. Shorten the mesh covering by approximately 2 inches and secure it with the provided heat shrink tubing using a heat gun. Install the hose on the input of the coolant pump and secure with a provided spring clamp.

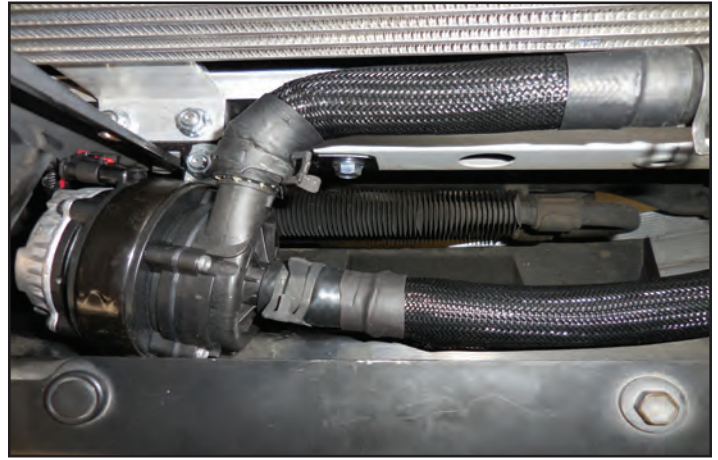

218. Plug in the two electrical connections (shown with green arrows), and press the plastic wire harness clips back into their slots (shown with yellow arrows).

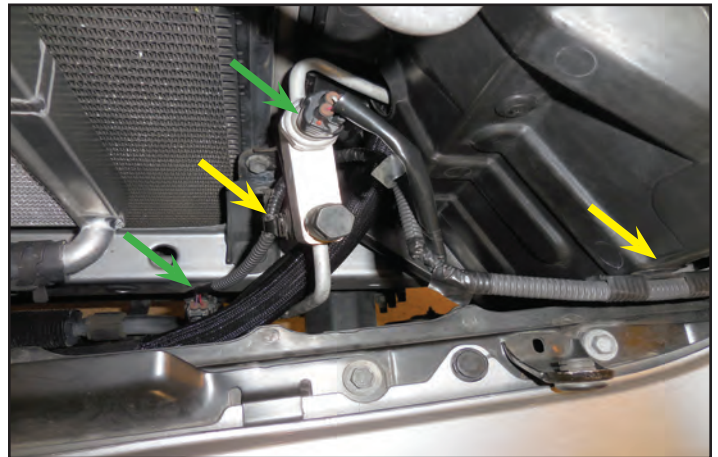

219. Gather the following hose assembly.



220. Secure the **provided 49"** long hose with mesh on it to the end of the hose assembly with a provided heat shrink clamp using a heat gun as shown. Ensure that the hose has gone to the stop on the plastic 3/4" Tee. Ensure that the hose clamp is approximately 1/8" from the end of the hose and that it has shrunk enough to seal the hose completely. The hose clamp should have a slight peak at the center of it like the other shrink clamps. Test the connection by pulling on it.



221. Install the hose assembly from the last step into the two lower spigots of the supercharger and secure with the provided spring clamps. Ensure that the clamp tabs point inwards as shown to give clearance for the upper hose assembly installation.



222. Route the 49" hose from the last step as shown here highlighted in green.



223. Route the 49" hose from the last step through the upper hole that was made in the plastic side curtain as shown here highlighted in green.



224. Trim the end of the hose to the length required to attach it on the upper LTR hose barb. Shorten the mesh covering by approximately 2 inches and secure it with the provided heat shrink tubing using a heat gun. Secure the connection with a provided spring clamp.

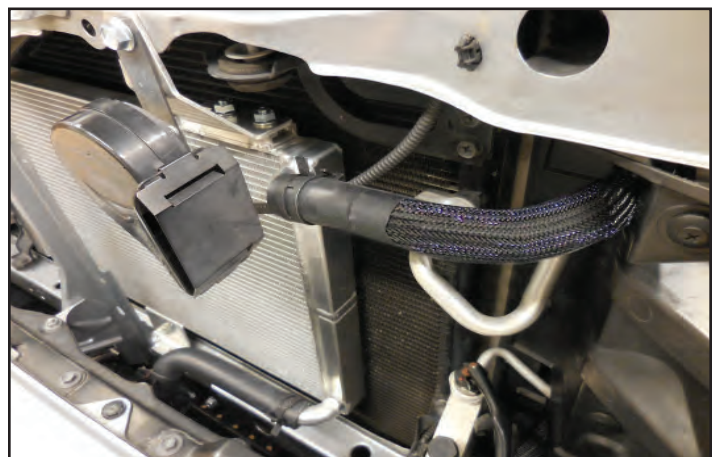

225. Gather the hose assembly shown.



226. Install the hose assembly from the last step into the two upper spigots of the supercharger and secure with the provided spring clamps.



227. Connect the opposite end of the hose assembly from the last step to the reservoir at the arrow location and secure with a provided spring clamp.



228. Gather the two large tie wraps, and the swivel spacer shown below. Slide the tie wraps from the last step through the swivel spacer to allow the connection of the two hoses shown with an arrow. **Do not crush either hose with the tie wraps.**

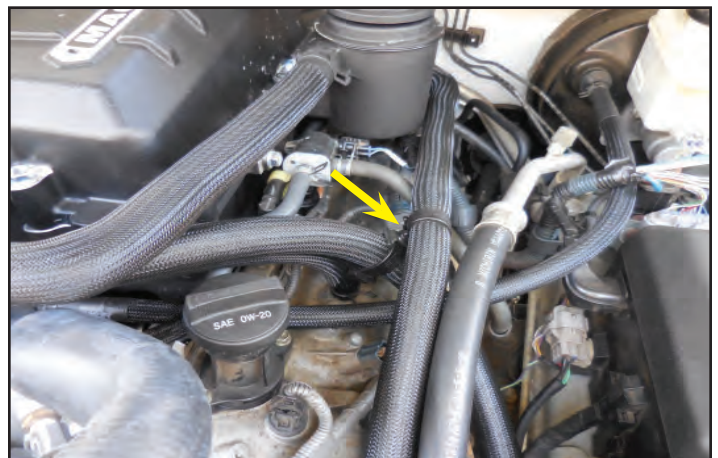

229. Use another provided cable tie to loosely secure the two hoses at the arrow location.



Section 10: Intercooler Pump Wiring Connections

230. Using a 10 mm socket remove the bolt at the location shown with a yellow arrow. Also remove the two bolts (shown with green arrows) that hold ground wires.

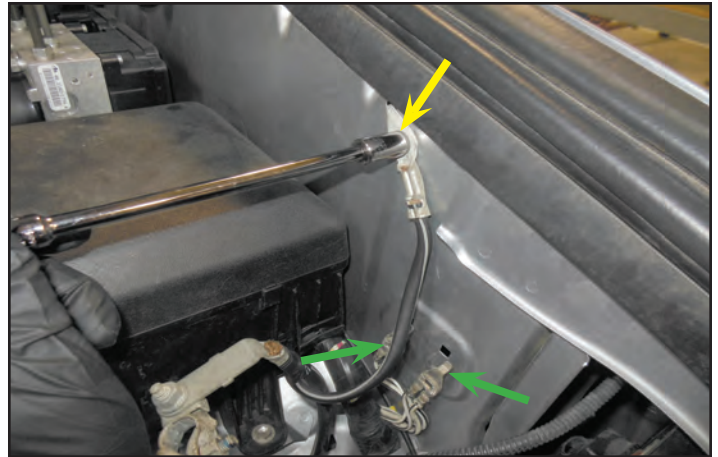

231. Gather the provided relay wiring harness. It will be used in the next few steps. Pull the yellow trigger wire through the tape on the end of the wire loom so it has more slack to route in a future step.

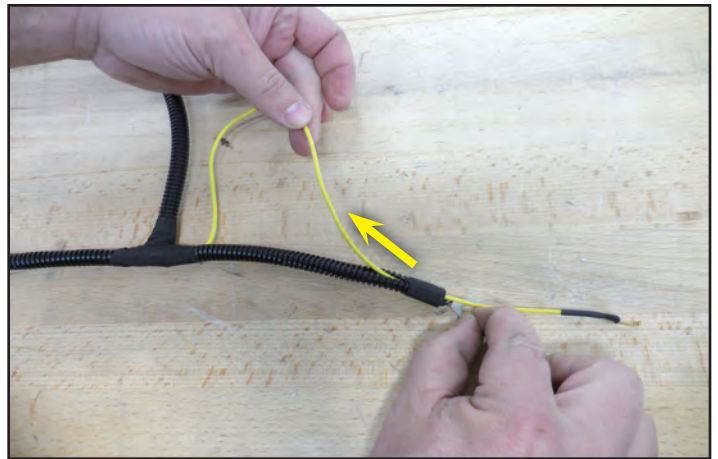

232. Install the provided 15 Amp fuse in the fuse holder for the relay wiring harness. Place the cover back on the fuse holder when you are done.



233. Install the provided harness bracket shown using the two bolts removed from the ground wire locations (shown with green arrows), and reinstall the ground wires. Incorporate the ground wire for the provided fuse holder with the bolt shown on the right. Install the fuse holder with a supplied nut (shown with a yellow arrow). Make sure the tabs on the two ground wires pass through the bracket and inner fender wall.

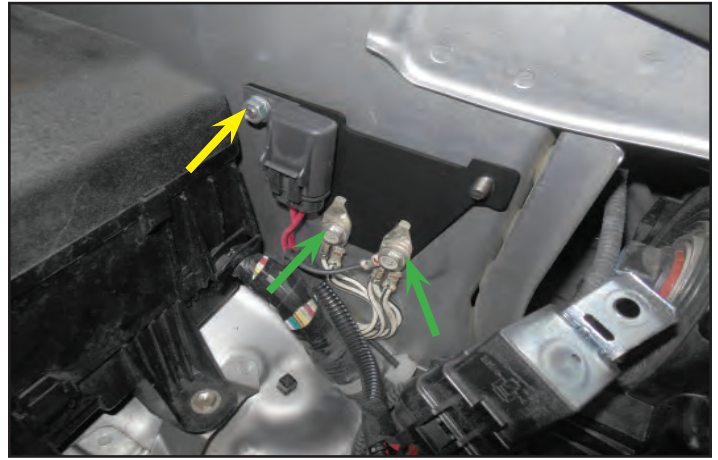

234. **Note: This step applies only to 2014+ Tundra. Ignore this step if you have a 2007-13.** You may not be able to feed the yellow trigger wire through the location shown in the following steps. If that is the case you will need to notch the edge of the fuse box to allow clearance for the wire once the lid is closed. Make that notch in the area shown with a red arrow. Allow enough clearance for the wire to avoid contact with the lid.

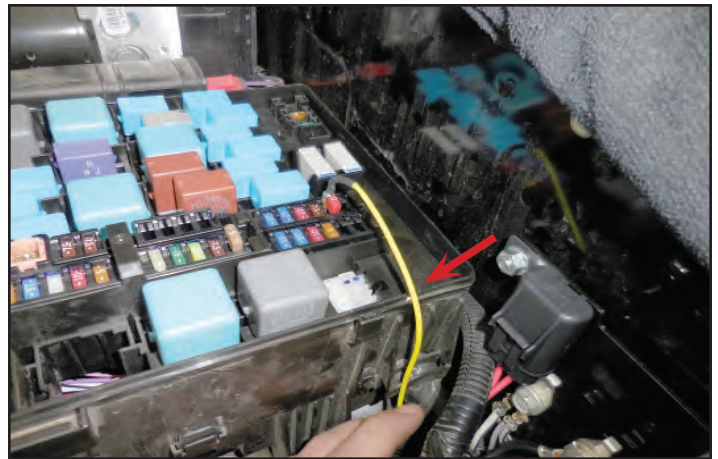

235. Secure the relay with a supplied nut (shown with a yellow arrow). Start feeding the yellow trigger wire into the fuse box where shown with the green arrow.



236. Continue to feed the yellow wire through the area shown with a yellow arrow using needle nose pliers. This will be attached to a fuse in a later step.

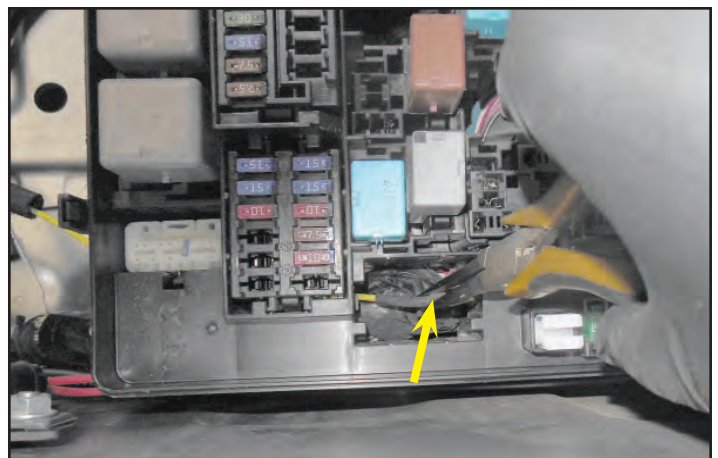

237. Secure the relay wiring harness to the wires going into the fuse box (shown with a red arrow). Make sure you have fed the yellow trigger wire all the way into the fuse box.

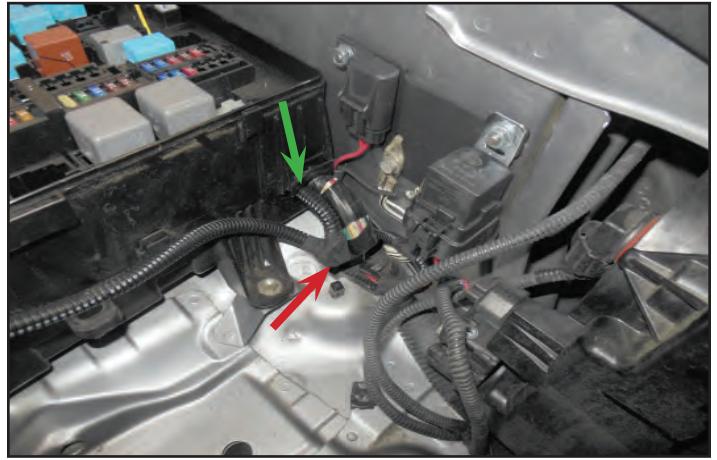

238. Reinstall the ground wire shown with the OEM bolt.



239. Install a cable tie around the relay wiring harness and through the hole in the fuse box (shown with a yellow arrow). Cable tie is shown uncut for clarity. Trim the excess cable tie. **Note:** The joint where the red wire exits the loom should line up with the edge of the fuse box (shown with a red arrow).

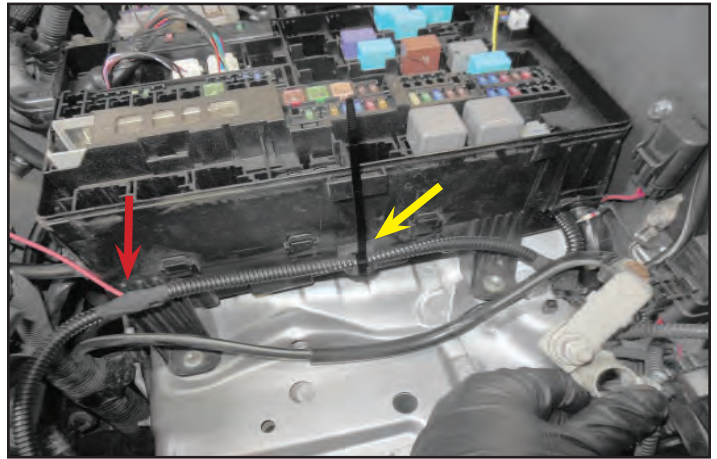

240. Install cable ties around the relay wiring harness and adjacent wiring harness and hard lines located at the yellow arrows. Trim the excess cable tie.

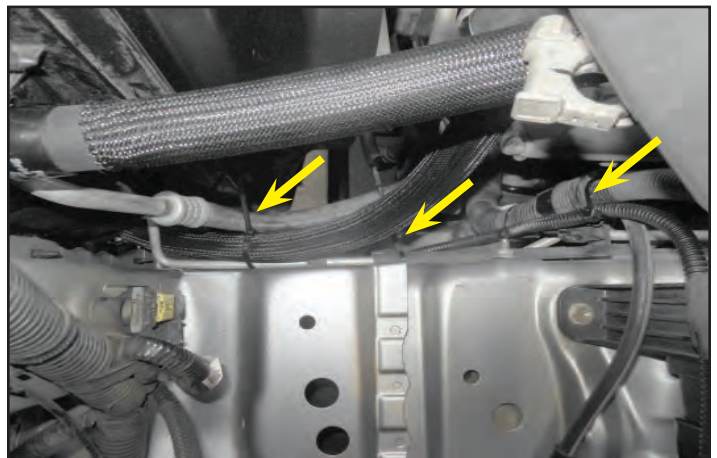

241. Route the relay wiring harness through the lower cut out in the left radiator deflector, following the hose leading to the pump inlet.

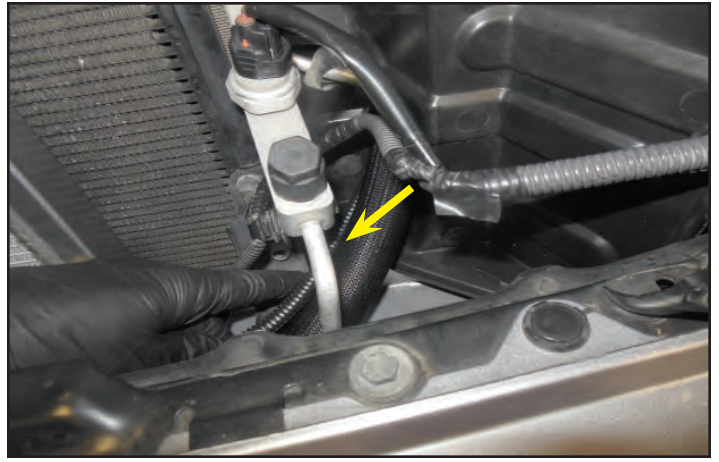

242. Connect the end of the relay wiring harness to the intercooler pump.



243. Secure the loose wire with a provided cable tie to a bracket to prevent the wire from coming disconnected.

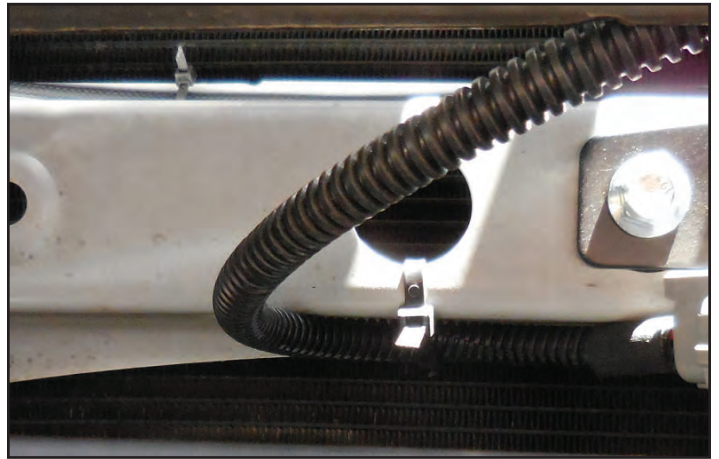

244. Install a cable tie at the location shown to secure the wiring harness to the hose. Bundle up any excess harness at this location.

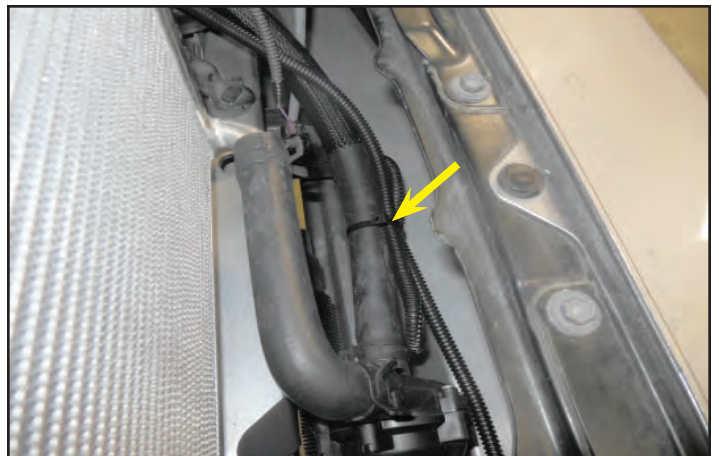

245. Reinstall the battery, and tighten down the positive lead. **Do not connect the negative lead.** Install the red lead from the provided relay wiring harness to the positive lead of the battery (shown with a yellow arrow). Cover the red wire with the provided piece of 1/2" loom incorporating the positive battery lead. Wrap the joint with electrical tape (shown with a green arrow).



246. Remove the 10 Amp fuse in the location shown. This is the closest fuse to the left fender. This fuse will be replaced. The fuse is labeled as "IGN" or Ignition. Verify you have removed the correct fuse by following the diagram on the underside of the fuse box lid.



247. Install the provided 10 Amp fuse over the metal terminal on the yellow wire that was routed into the fuse box in an earlier step. This will trigger the intercooler pump to turn on.

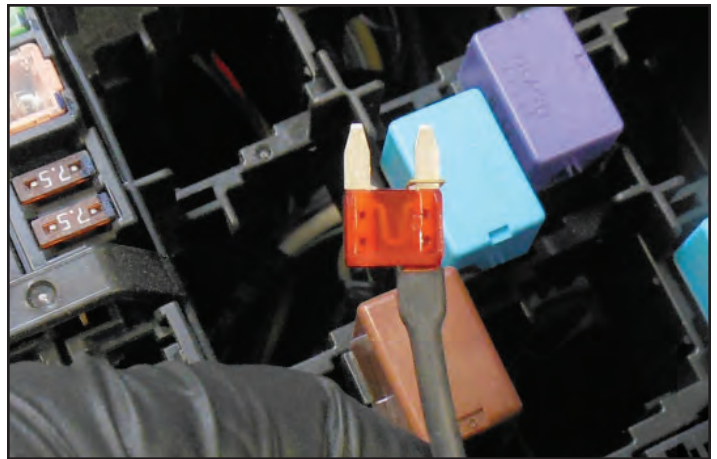

248. Insert the fuse which was attached to the yellow wire in the last step back into the location where the OEM 10 Amp fuse was removed. Again double check you have replaced the fuse in the correct location.



Section 11: Fuel Pump Replacement

Refer to the owners manual for proper lifting of vehicle. Ensure that the vehicle is properly supported while working under it. Failure to properly support the vehicle may result in injury or death.

249. Raise the vehicle to access the fuel tank. If required, remove the fuel tank protector by removing the 2 bolts & 2 nuts.



250. Find the fuel lines shown that will be disconnected.



251. Have rags ready to soak up any excess fuel before disconnecting. Disconnect the fuel feed and return lines (shown with yellow arrows). Lift up on the cover to detach the safety lock. Now pinch in on the two sides and pull the line loose.

Take care not to damage these connections. If these lines get kinked, they will need to be replaced.

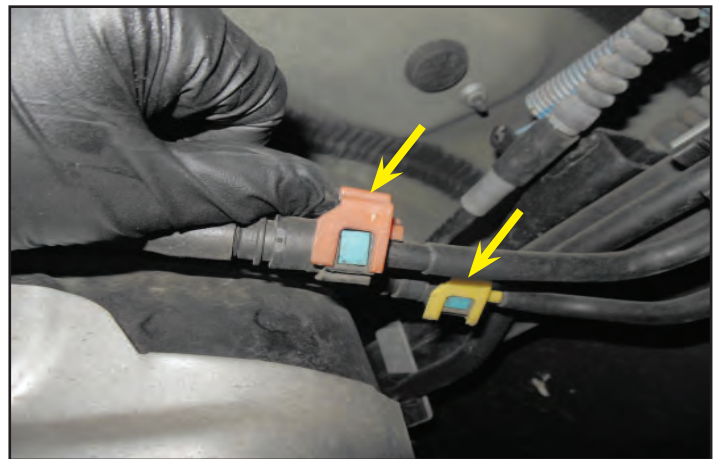

252. Pull outward on the retainer clip to disconnect the vent hose.



253. Disconnect the wire harness clip from the top side of the fuel tank.

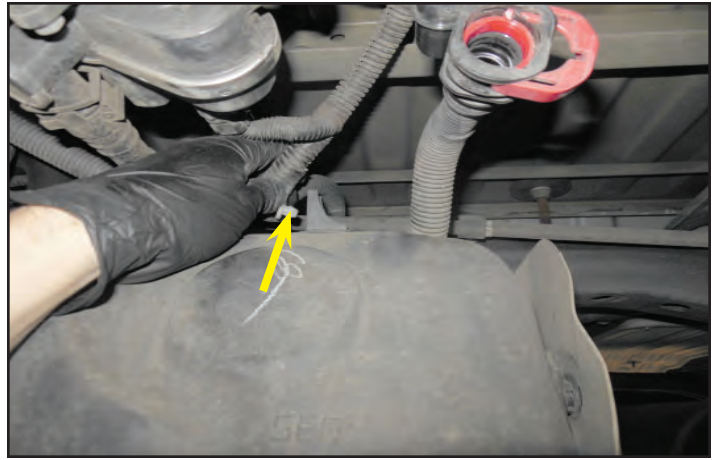

254. Disconnect the two hoses shown with yellow arrows. You may have to remove the hose shown with the blue arrow as well. For reference the green arrow is pointing to the backside of the fuel tank filler neck.

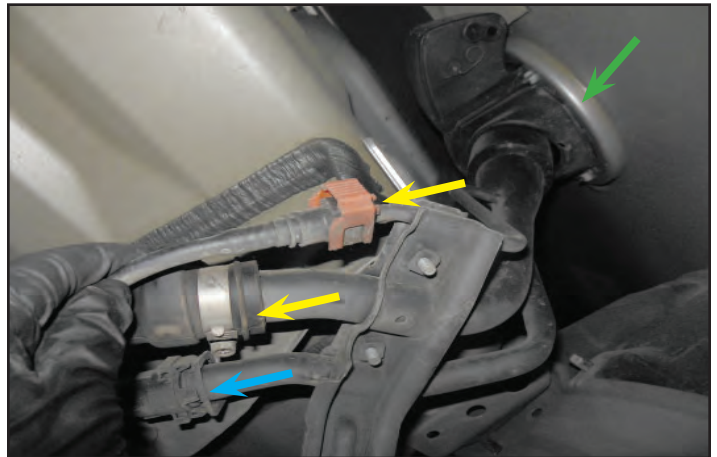

255. Follow the three lines you just disconnected back to the frame rail and release them from the retaining clips.

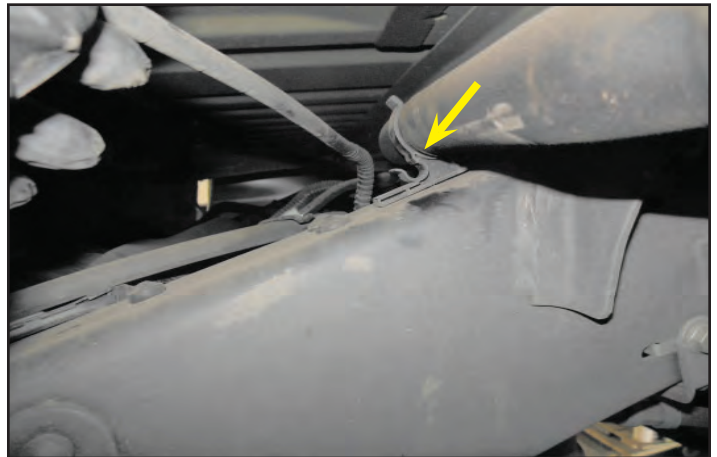

256. Support the fuel tank with an appropriate stand. Unbolt the two tank bands. **Make sure the tank is properly supported.** Once you remove these two bands the tank can drop down.



257. Remove the pins from the opposite side of the straps and remove both bands.



258. Remove harness clip located at the top of the tank. This clip is located on the upper left side of the tank near the frame rail. You may need to drop the tank an inch or two to access this clip.



259. With the center harness clip disconnected slowly lower the tank. Stop after the tank has been lowered about 6 inches. You will have to reach back on top of the tank and remove the plastic cover on top of the fuel pump assembly.



260. Here is the cover that was just removed from the top of the tank.



261. Unplug the electrical connection for the fuel pump from under the cover that was just removed. This should be the last connection to the fuel tank. Continue to slowly lower the tank making sure it does not pull on any surroundings as you lower it.



262. Thoroughly clean and blow out any debris from around the fuel pump assembly.

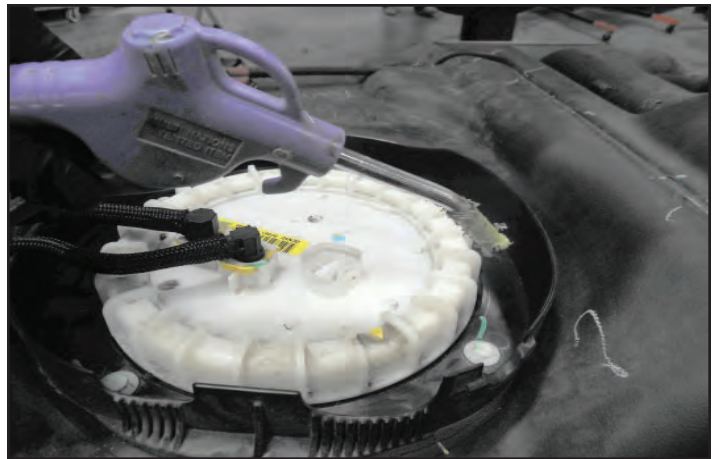

263. Remove the joint clip from the two fuel tank fittings. Then pull the fuel tank fittings out. Wrap the ends in a rag and gently move them out of the way.



264. Use a fuel tank lock ring tool to remove the outer lock ring. As you loosen the ring you will have to unclip the three lock tabs on top of the pump assembly every 1/3 rotation. **Do not damage these lock tabs.**



265. Remove the fuel pump assembly from the tank along with the O-ring. Discard this O-ring since a new one is supplied. Cover the tank opening to prevent debris from falling inside it.



266. Unplug the two wire connections shown with green arrows.

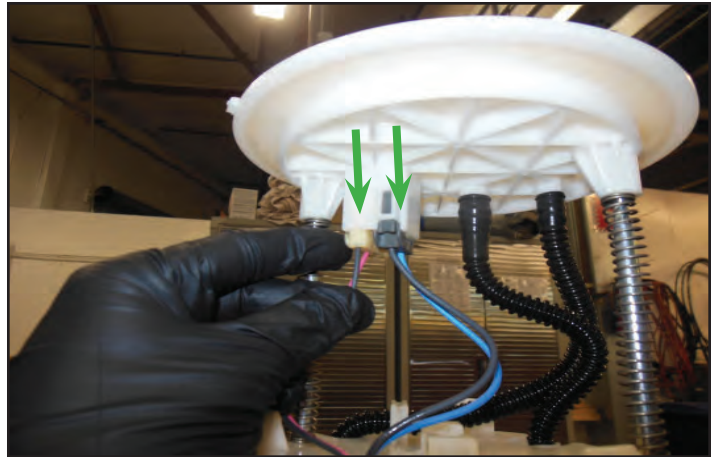

267. Press in on the sender gauge claw (shown with a red arrow) and pull up on the sender gauge to remove it. Unplug the fitting shown with the yellow arrow. Also unclip the red/black wires from the grey clip which runs to the sender gauge sensor. Set the sender assembly aside on a clean surface.

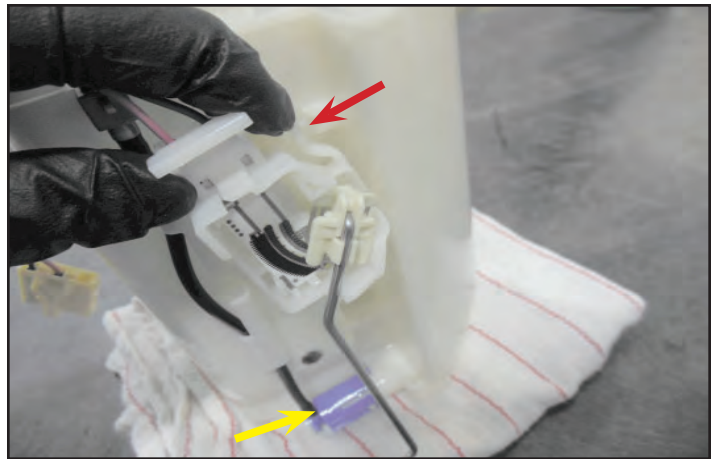

268. Pull the wire loom away from the clip shown with an arrow.

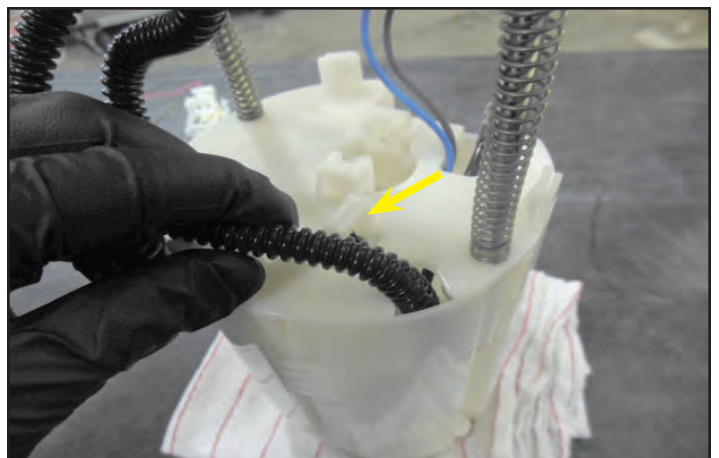

269. Lightly pry the 3 claws (shown with red arrows) away from the housing to remove the top. Lightly pry the two claws (shown with yellow arrows) to detach them from the sides.

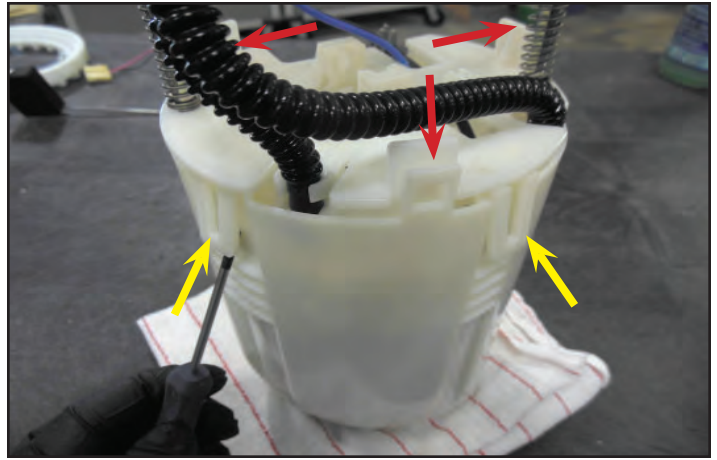

270. The upper lid from the housing is shown being removed. Set it upside down on the table.

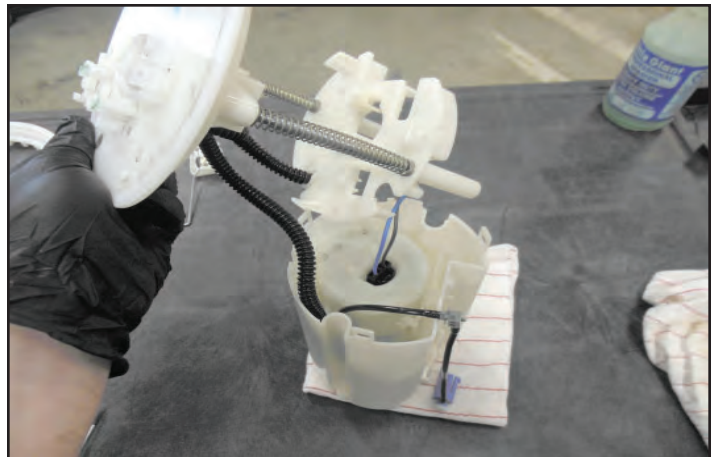

271. Pry up on the two claws as you remove the final inner assembly from the housing.



272. Clean out the inside of the housing. Use some clean rags and Simple Green to make sure all dirty fuel, and debris has been completely removed.

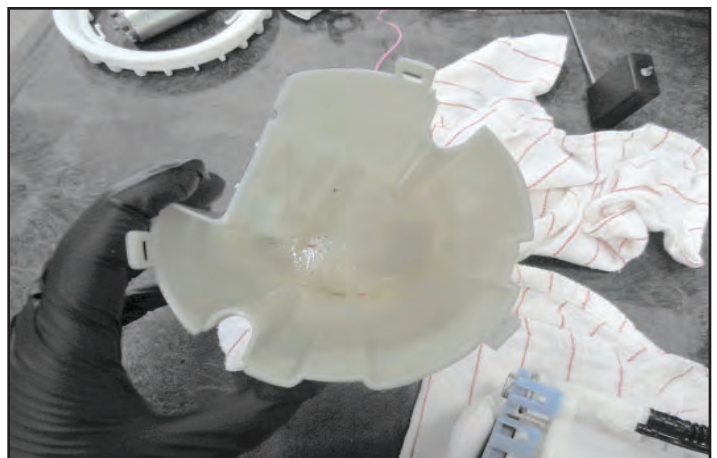

273. Pry the 5 clips of the pump retainer (blue plastic) to remove it. Work them one at a time ensuring that they stay disengaged as you work your way around the retainer.



274. Remove the fuel pump from the assembly, and unplug the electrical connector.



275. Remove the spacer shown from the OEM fuel pump.



276. Remove the OEM O-ring from the bottom of the inner housing (shown with an arrow). This will be discarded. If it is not in the housing then it should be stuck to the pump. Do not gouge the housing when removing the O-ring.



277. Install the spacer with the slots facing down on the newly provided fuel pump. Apply a light coat of Lubriplate grease on the supplied fuel pump discharge O-ring, and insert the pump back into the housing making sure to plug the electrical connection back in. Continue to reassemble the entire pump assembly following the previous steps in reverse.

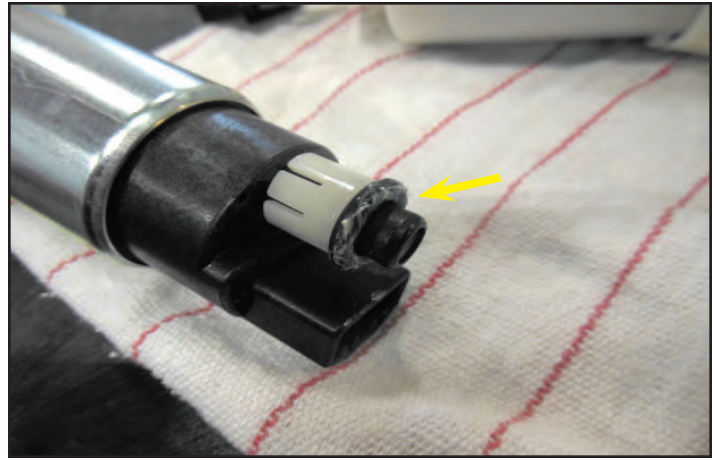

278. Apply Lubriplate grease to the newly provided fuel pump module O-ring and install into the groove. Make sure both sides (top/bottom) of the O-ring have a light coat of grease.



279. Align tab on fuel pump module with the notch in the tank (shown with an arrow) during reinstallation. Hold the module in place while you thread the retainer ring on loosely by hand.

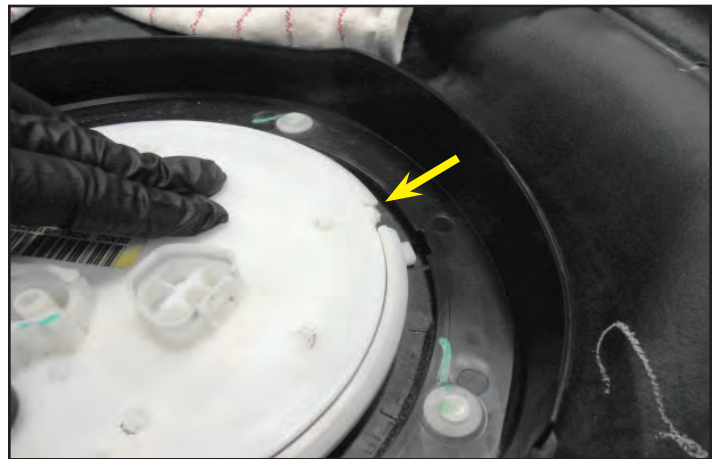

280. Use the lock ring tool to tighten the ring. Make sure the yellow arrow lines up with the yellow mark on the tank.

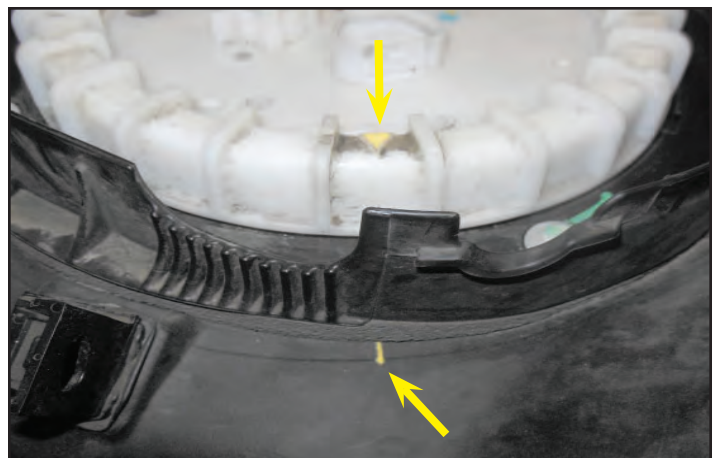

281. Re-Install the two fittings and lock tabs into the fuel pump assembly.



282. Make sure the lines running to the fittings installed in the last step are properly retained on the top of the tank



283. Follow the steps at the beginning of this section in reverse to re-install the fuel tank. Ensure that all electrical lines, and fuel lines are reconnected, and properly routed. Make sure that all safety fasteners are fully engaged. Re-install the bands with the OEM pins and bolts. **Torque the bolts holding the bands to 30 ft-lbs.** Reinstall the OEM tank protector with the 2 OEM nuts and bolts if removed earlier.



Section 12: Coolant Fill, and Final Testing

284. Ensure that the drain plug for the radiator is closed. Fill the radiator with a Toyota approved coolant mixture. Re-install the radiator cap. If you saved and reused your coolant, make sure it all gets reused. You may need to add some to the overflow tank to the right of the radiator.



285. Reconnect the negative lead of the battery and tighten the nut with a 10 mm wrench.



Make sure that you have followed step #1 in this manual to load the proper supercharger calibration to your vehicle's ECM.



286. Fill the intercooler reservoir with a Toyota approved coolant mixture until it is full. Have someone else cycle your ignition switch to the accessory mode to trigger the pump on. **Do not start the vehicle!** This will circulate the fluid. Once the reservoir drains turn the pump off, and fill again. **Do not allow the reservoir to run dry.** Repeat until full circulation is achieved with a full reservoir. Fluid level should be just above the top barb. Re-install the reservoir cap.



287. Check the serpentine belt to see that it is aligned properly on all the pulleys. Start the engine and let it idle. Check for fuel, and coolant leaks. Squeeze the inlet and outlet hose on the radiator to remove trapped air from the system. Check the air intake for leaks, and tighten any loose fittings. Shut down the engine, and allow it to cool. At this time you can reinstall the skid plate that was removed in section #2. Also if you have a 2014+ truck reinstall the front grille.



288. Once the engine has cooled down check the level of the radiator reservoir, and the intercooler reservoir. Add coolant if necessary. Test drive the vehicle for the first few miles under normal driving conditions. **Do not perform any wide open throttle runs.** Check for any unusual sounds, vibrations, or engine misfires. The supercharger does have a slight whining noise under boost conditions, which is normal. After the initial test let the engine cool down, and recheck coolant levels.



289. After the initial test drive gradually work the vehicle to wide open throttle runs. Listen for any engine detonation (pinging). If engine detonation is detected let up on the throttle immediately. Most detonation is caused by low octane gasoline still in the tank. Premium 91 octane fuel is required. Enjoy your new supercharger!

If you have questions about your vehicles performance, please check with your installation facility.

After you finish your installation and road test your vehicle, please fill out the warranty registration. This can be found on our website.



Appendix A

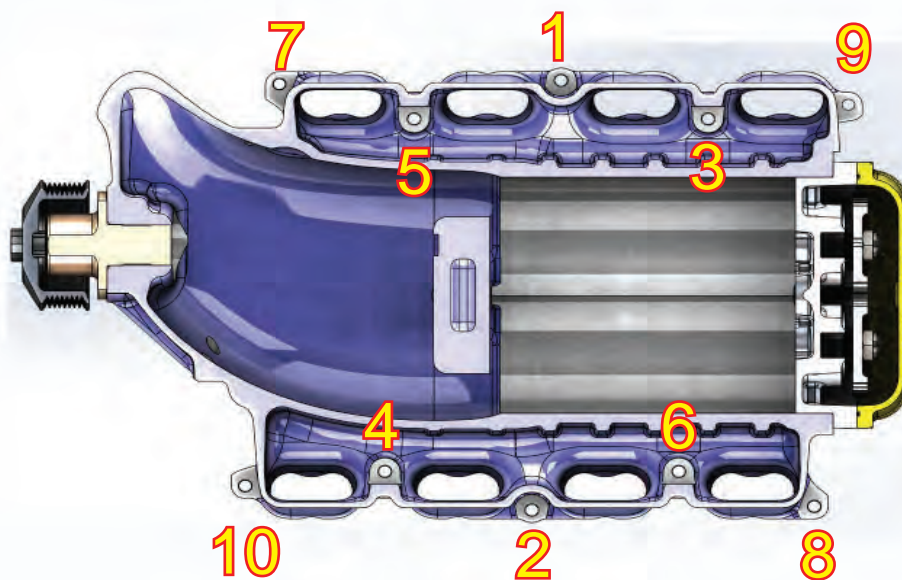

**Supercharger Torque Sequence
(15 ft-lbs. Final Torque)**

Appendix B

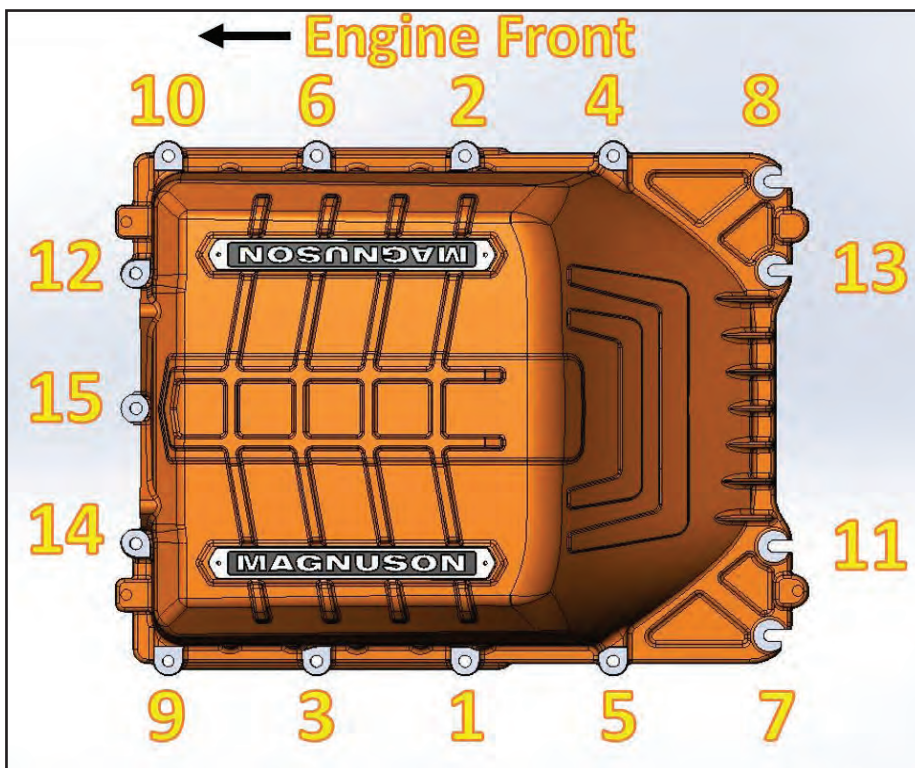

Lid Torque Sequence
(18 ft-lbs. Final Torque)

Appendix C

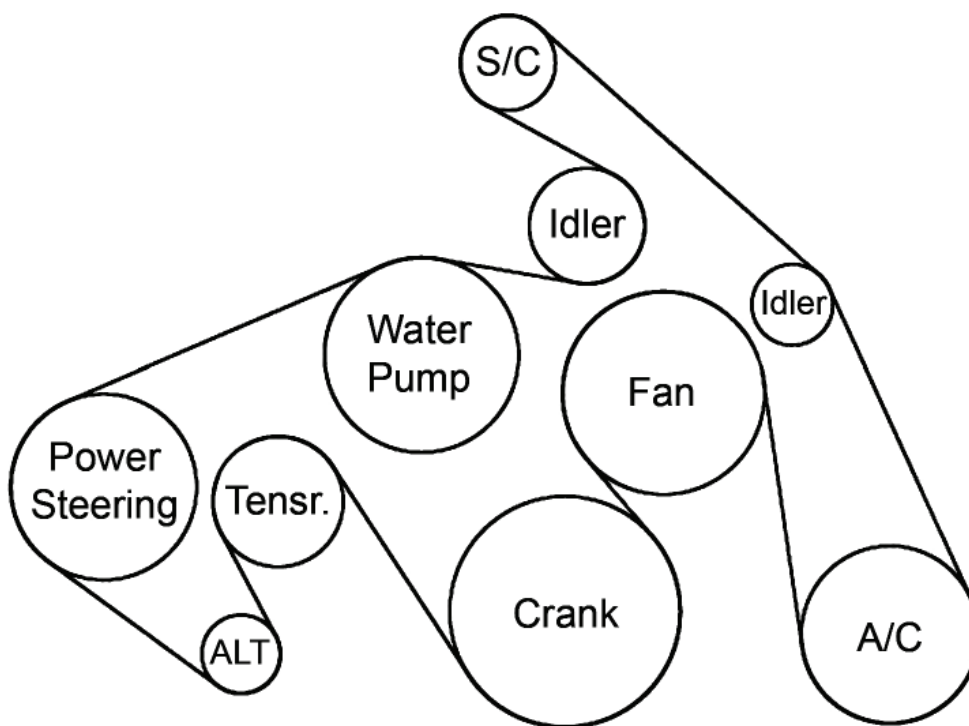

Belt Routing Diagram

Notes



Use only premium gasoline fuel, 91 octane or better.

MAGNUSON
SUPERCHARGERS