

MAGNUSON

SUPERCHARGERS

Installation Instructions for:
TVS1900 to TVS2650 Upgrade
Toyota Tundra 5.7L



*** PREMIUM GASOLINE FUEL REQUIRED ***



ATTENTION!
Your MAGNUSON SUPERCHARGER kit
is sensitive to corrosion!
Use only the vehicle manufacturer
recommended coolant for your engine in
the intercooler system as well.

Magnuson Products LLC
1990 Knoll Drive, Bldg A, Ventura, CA 93003
(805) 642-8833 phone
magnusonsuperchargers.com

INSTALLATION MANUAL

Magnuson Supercharger TVS2650 Upgrade Kit: Toyota Tundra 5.7L

This upgrade kit was designed as an upgrade to the Magnuson TVS1900 supercharger kit. If you have a TVS1900 supercharger kit it will take some addition work and parts to upgrade.

Please take a few moments to review this manual thoroughly before you begin work: Make a quick parts check to be certain your kit is complete (see Bill of Material (BOM) parts list inside the accessory box). If you discover shipping damage or shortage, please call our office immediately. Take a look at exactly what you are going to need in terms of tools, time, and experience. Review our limited warranty with care.

Use only premium gasoline fuel, 91 octane or better.

Magnuson Products recommend that you run a minimum of one (1) tank of premium fuel through your vehicle prior to installation of the system to prevent any possible damage that may occur due to running the supercharged engine on lower octane fuel.

Magnuson Products Supercharger systems are designed for engines and vehicles in "GOOD" mechanical condition. Magnuson Products recommend that a basic engine system "Health Check" be performed prior to the installation of this supercharger system. Be sure to check for any pending or actual OBDII codes and fix/repair any of the stock systems/components causing these codes. If there are codes prior to the installation they will be there after the installation.

Magnuson Products also recommend the following services to be performed on your vehicle before starting and running the vehicle post supercharger system installation:

- Fuel Filter change
- Engine oil and filter change using brand name oil (organic or synthetic) and filter
Note: It is VERY IMPORTANT to use the factory specified oil viscosity. The original equipment manufacturer has selected this grade of oil to work with your other engine systems such as hydraulic chain tensioner and variable cam controls. Deviation from this specification may cause these systems to fail or not function properly. Please refer to your owner's manual for the recommended oil viscosity for your engine and application.
- On newer vehicles not requiring new spark plugs it is important to verify the spark plug air gap.

On older vehicles Magnuson Products recommend these additional services to be performed:

- New spark plugs with the air gap set at the factory specifications OR new specifications if required by the installation manual.
- Coolant system pressure test and flush. **NOTE: YOU MUST USE TOYOTA SPECIFIED COOLANT MIXTURE!**

Non "Magnuson Approved" calibrations or "tuning" will Void ALL warranties and CARB certification.

Our supplied calibration is designed for use with the components provided in this kit. Any adjustment to the intake, or exhaust systems or other engine components may adversely affect engine performance and may trigger your check engine light.

Drive belt = Dayco 5081153

Tools Required

- Metric wrench set**
- Metric 3/8" and 1/2" drive metric socket set (standard & deep)**
- 3/8" and 1/2" drive ft-lb. and in-lb. torque wrenches**
- Metric Allen socket set 3/8" drive**
- Metric Allen wrenches**
- Torx socket set 3/8 drive**
- Phillips and flat head screwdrivers**
- Funnel**
- Drain pan**
- Hose cutters**
- Hose clamp pliers**
- Safety glasses**
- Compressed air**
- Air gun**
- Heat gun**

Contact Information:

Magnuson Superchargers
1990 Knoll Drive, Bldg A
Ventura, CA 93003

Sales/Technical Support Line (805) 642-8833
Websites www.magnusonsuperchargers.com
Email sales@magnusonsuperchargers.com

Table of Contents

Section 1: Initial Preparation	5
Section 2: Coolant Drainage	6
Section 3: TVS1900 Supercharger Removal	8
Section 4: TVS2650 Supercharger Installation	13
Section 5: Serpentine Belt, Throttle Body and Hose Installation	19
Section 6: Coolant Fill, and Final Testing	31

NOTE: This instruction manual follows the process we used to complete this installation on our test vehicle. This does not imply there aren't alternate approaches. If you find a procedure or process that improves the installation, please let us know! We strive to create the most comprehensive and complete instruction manuals available.

Section 1: Initial Preparation

1. **If your kit has a provided handheld tuner follow the instructions in the provided pamphlet to install your tune. Your handheld tuner may not match the one shown.**



2. Your Intercooler system is sensitive to corrosion. It's very important to use the OEM recommended coolant mixture in your supercharger system as well.



3. Your system requires the use of a minimum 91 Octane gasoline fuel. This system is **not** compatible with E85 fuel.



Any reference to the left or right side of the vehicle is given from the driver's seat perspective.

4. Disconnect the negative (-) battery lead with a 10mm socket wrench. Wrap the connection with a shop towel and set it aside to prevent it from making connection.



Section 2: Coolant Drainage

Allow the engine to cool down before draining any fluids.

5. Remove the skid plate. Use a 12 mm socket to remove the 5 bolts shown with red arrows (3 in back, and 2 up front). Use a 10 mm socket to remove an additional 3 bolts shown with yellow arrows.

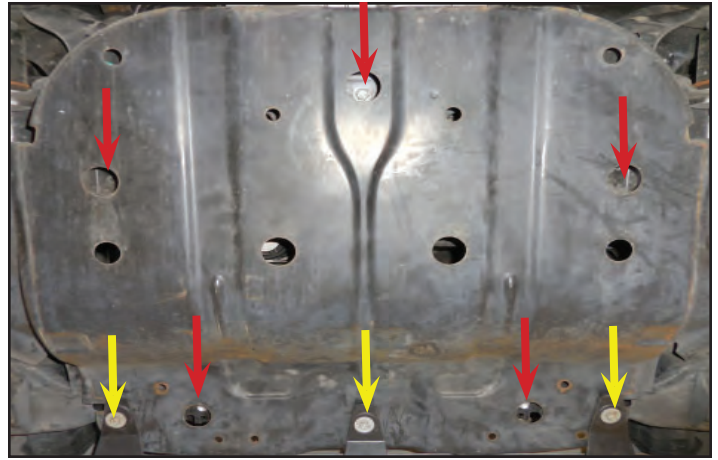

6. View of skid plate being removed.



7. Drain the coolant by opening the drain plug at the location shown with the arrow (lower left corner of the radiator). Have a clean pan, or bucket, ready for catching the fluid so that it may be reused.



8. Let the system drain completely before removing any hoses. This will take approximately 15 minutes to drain completely. Complete the next step to speed up this process.



9. Remove the radiator cap to help the coolant drain faster. Once the coolant has fully drained replace the cap, and tighten the drain plug.



10. Remove the clamps for the upper radiator hose where indicated with yellow arrows. Mark the end of the hose with a pen at the blue arrow area to indicate that this is the radiator side. This hose will be flipped when it is reinstalled later.

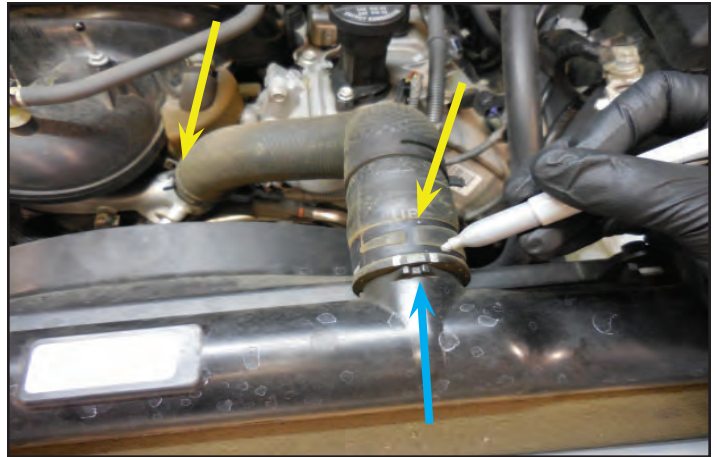

11. **Place some rags under the hose connection at the cross over to prevent coolant from getting on the belt/pulleys.** Remove the upper radiator hose.



12. Plug both coolant hose connections with clean towels to prevent anything from falling into them.



Section 3: TVS1900 Supercharger Removal

13. Use a breaker bar with a 14 mm socket and release the tensioner (located at the arrow) to remove the serpentine belt. **This belt will be replaced with the provided one in a later step.**

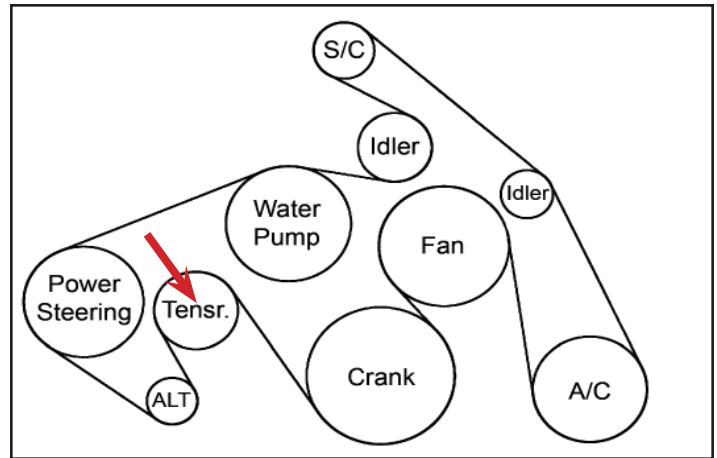

14. Remove the ventilation hose assembly with the OEM fasteners in the locations shown with the arrows and the each of the three hose ends. **Parts from this hose assembly will be used in other locations for the 2650 supercharger installation.**



15. Here is the ventilation hose assembly from the last step. The green highlighted hose section will be used later.



16. Unlatch the four spring clamps that secure the lid in place (One clip is shown at yellow arrow).



17. Loosen the two hose clamps for the air inlet tube and remove it from the airbox and the throttle body.



18. Remove the two coolant hoses that connect to the throttle body. Save these hoses for use later.



19. Remove the throttle body by removing the 4 bolts. The orientation of the throttle body will change for the new supercharger.



20. Disconnect the three hoses shown at the arrows.

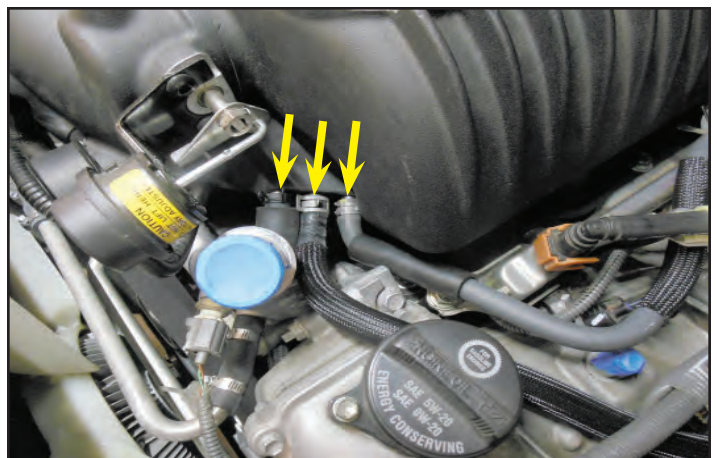

21. Disconnect the hose and electrical connection at the VSV valve shown with arrows.

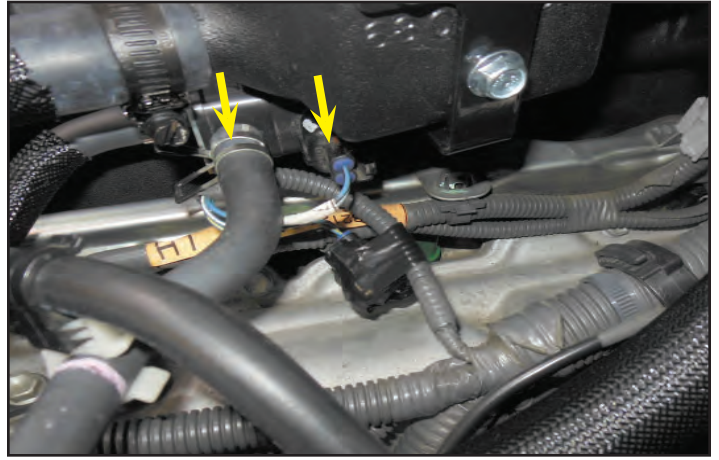

22. Place a drain pan under the intercooler pump. Remove the pump input hose at the yellow arrow and drain the intercooler system.

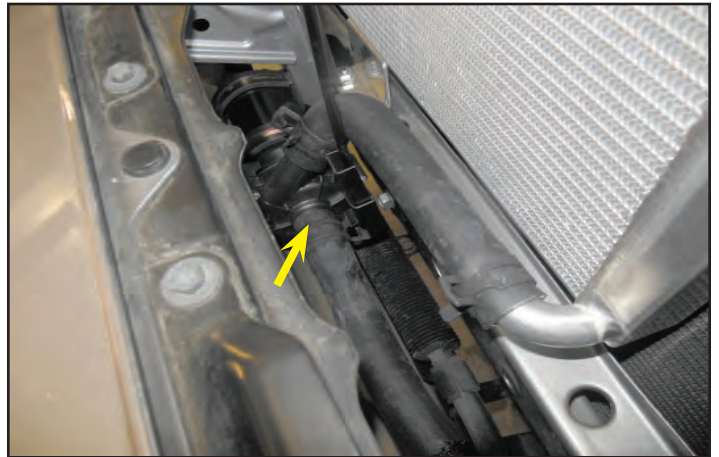

23. Once the intercooler system is drained you will need to remove the opposite end of the hose that you just disconnected. This can be seen at the arrow here on the reservoir.

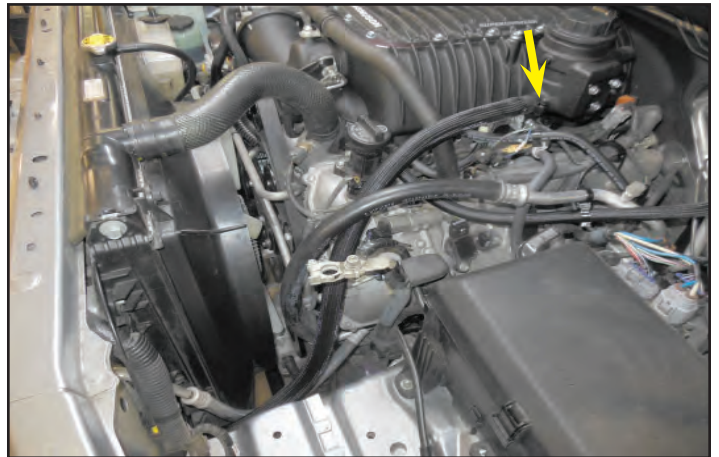

24. Cut and remove the cable tie at the arrow location.



25. Disconnect the coolant hose at the top rear of the supercharger shown with the arrow.

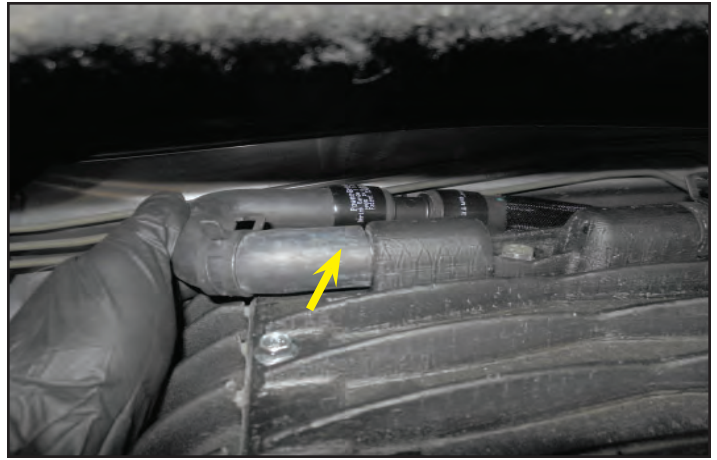

26. Remove the upper LTR hose at the arrow location. Remove this hose assembly from the vehicle.

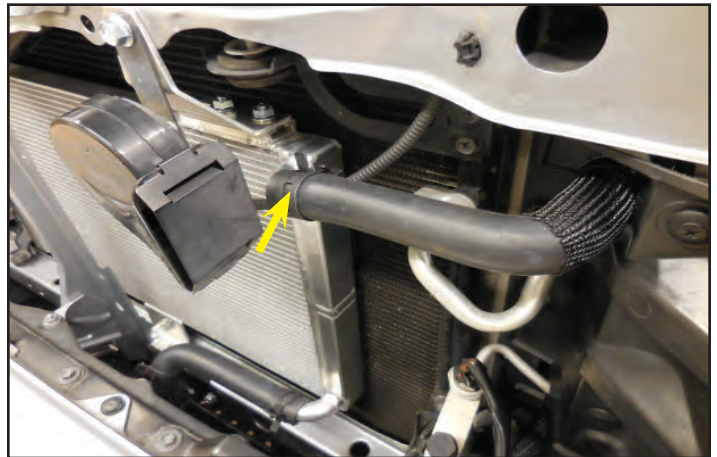

27. Here is a photo of the hose assembly from the last step. This hose will be modified and reused later.



28. Remove the hose at the back of the reservoir.



29. Remove the intercooler reservoir from the bracket at the 3 bolt locations. This reservoir and the bolts will be reused.

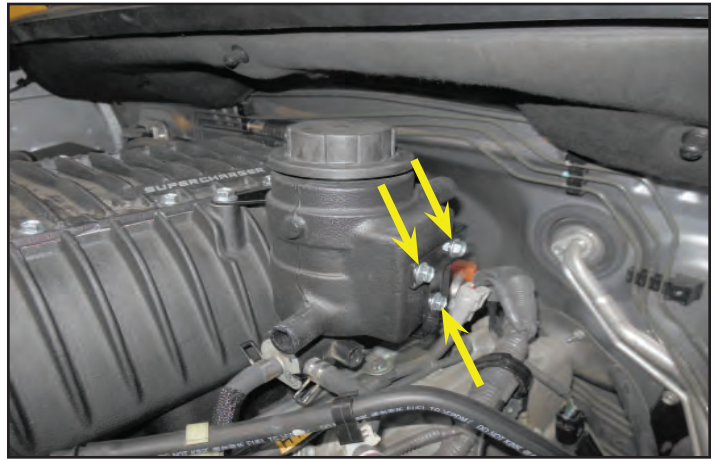

30. Remove the two bolts at the top of the reservoir bracket.



31. Remove the two Allen head bolts from the lower part of the reservoir bracket.

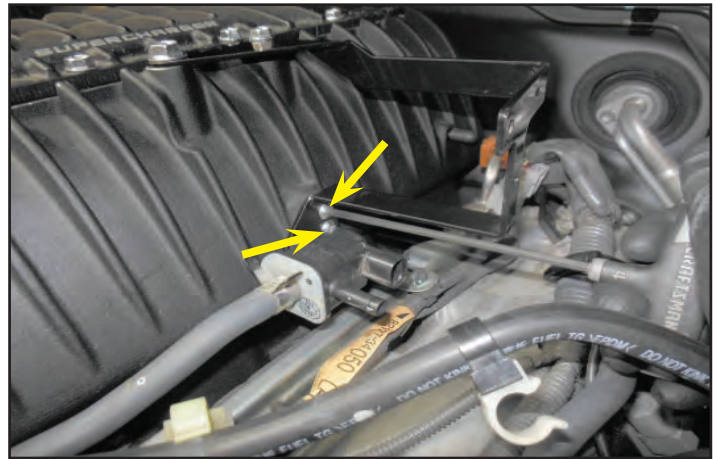

32. Remove the one Allen head bolt holding the VSV valve on the reservoir bracket. The bracket will not be reused but the VSV valve, bolt and washer will.

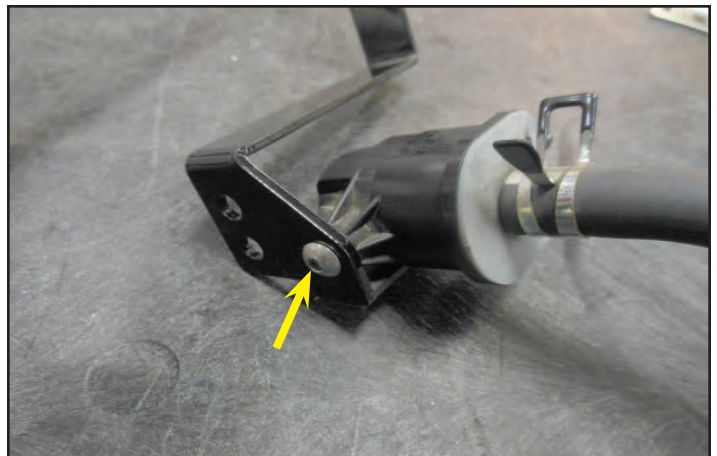

33. Remove the 10 bolts that secure the supercharger to the engine.



34. With the help of a few friends, remove the supercharger assembly from the engine. A hoist like the one shown is the preferred method for removal. **Be careful not to damage the gaskets on the underside of the supercharger.**



Section 4: TVS2650 Supercharger Installation

35. Tape off the intake ports to prevent debris from falling into the engine. (Note: This image shows the OEM foam in the engine valley. These should be removed if still present.)

It is VERY important to not contaminate your work environment or allow any debris to fall into the exposed ports, or engine damage can occur.



36. **Note: This step applies only to 2014+ Tundra. Ignore this step if you have a 2007-13.** Remove the old straight hose highlighted in green here at the arrow location. This will be replaced with a hose that was removed earlier which will be modified in the next step.



37. **Note: This step applies only to 2014+ Tundra. Ignore this step if you have a 2007-13.**

Mark and cut the old hose that was removed from the throttle body that does not have mesh at the arrow location.



38. **Note: This step applies only to 2014+ Tundra. Ignore this step if you have a 2007-13.**

Install the hose from the last step at the arrow location using the provided hose mender and two clamps as shown. The opposite end of this hose will connect to the throttle body with a clamp in a later step.



39. Disconnect the coolant hose from the hardline where shown.



40. **Supercharger shown installed for reference only.** Slide a long socket extension, or similar metal bar, into the coolant tube at the arrow location. We combined two 3/8" socket extensions to allow us to safely bend the tube without kinking it. Slowly bend the tube approximately 1" closer to the radiator and 1/2" down. This will provide the clearance for the throttle body.



41. Reinstall the OEM coolant hose from two steps ago and secure with the clamp.

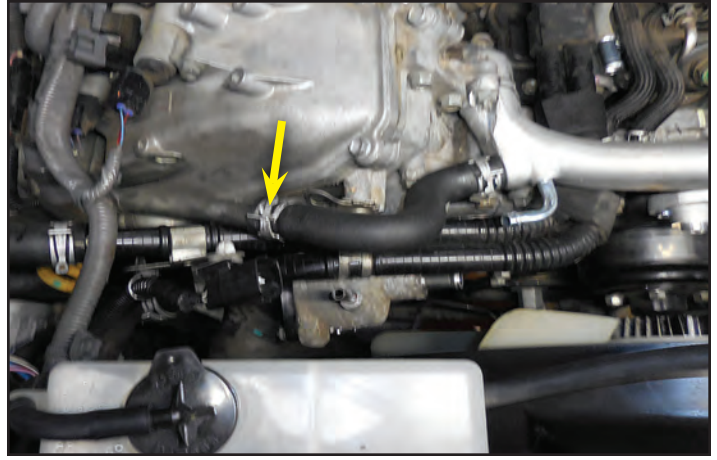

42. **Discard the rear foam engine cover if it is still there (shown with an arrow).** Make sure everything is clear of the engine valley. Remove the tape covering the intake ports.

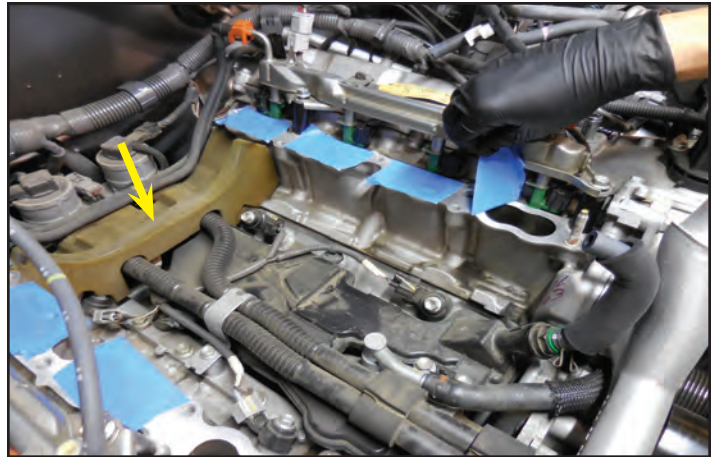

43. Spray Tri-Flow (or equivalent PTFE based lubricant) on a clean towel and wipe the intake surfaces.



44. Remove the lid bolts and the lid.



45. You can install some long M8 bolts into the 4 arrow locations around the perimeter of the supercharger to enable installation.

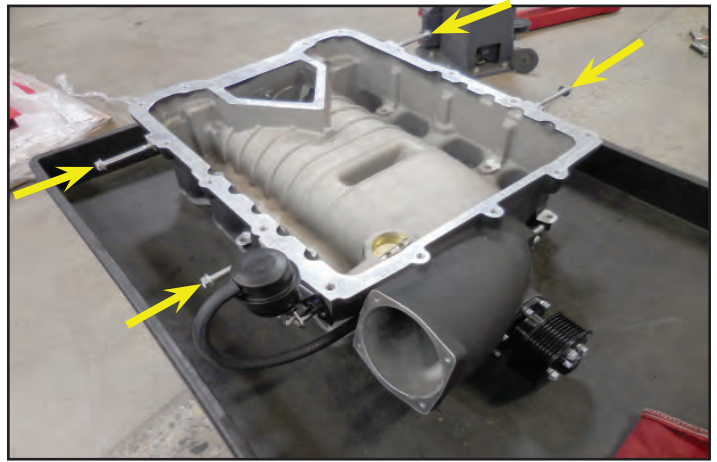

46. Remove the left and right OEM intake gaskets from the old TVS1900 supercharger. Clean and inspect the gaskets. Replace if damaged. Apply a light coat of clean motor oil to the gaskets.



47. Flip the TVS2650 supercharger upside down on a suitable clean soft surface and install the OEM gaskets into the grooves. Ensure that the gaskets are fully engaged in all the grooves.



48. Apply Loctite 242 to the 4 provided M8x75mm bolts and the 4 OEM manifold bolts and two OEM nuts.



49. With the help of a few friends, place the supercharger assembly onto the engine. **Be careful not to damage the gaskets on the underside of the supercharger.** Lightly install the 4 longer bolts from the last step in the arrow locations.

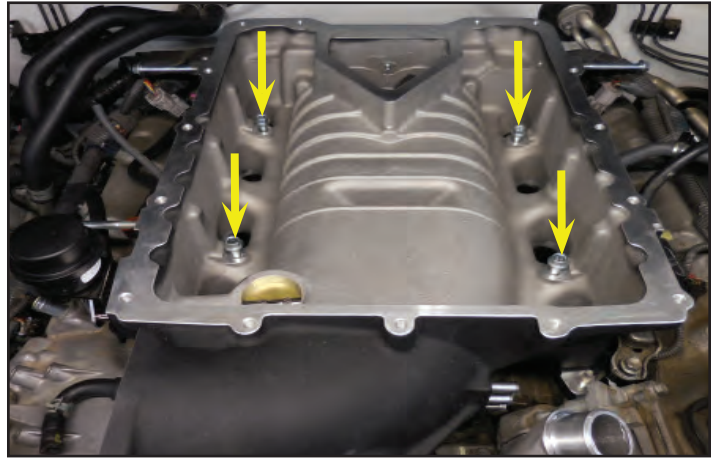

50. Install the OE bolts and nuts to secure the supercharger in place. Use a telescoping magnet to drop the bolts in place. The nut goes at the front stud on both sides. There are 3 more of these locations on the other side.

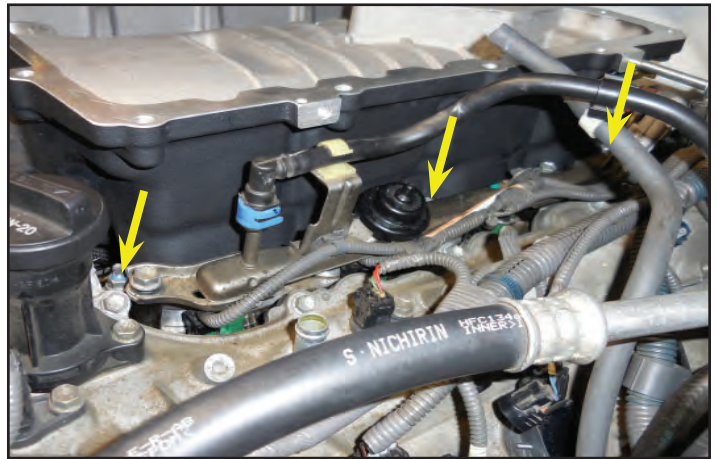

51. **Note: The boost reference port location is shown at the arrow. You can replace the provided plug at this location with a barbed connector to allow the installation of a boost gauge.**



52. **Follow the torque sequence given in the diagram at the back of this manual. Torque the manifold bolts to 15 ft-lbs. Also at this time torque the 4 fuel rail bolts to 15 ft-lbs.**



53. Apply Loctite 242 to the 13 M8x30mm, and 2 M8x50mm lid bolts that were removed earlier.



54. Pre-install the 4 M8x30mm bolts at the back of the supercharger housing. You only need to engage a few threads at this time.



55. Use rubbing alcohol to clean the area on the lid where the two Magnuson badges will be installed.



56. Apply Loctite 242 to the four M4x8mm button head badge bolts.



57. Peel the covering off the adhesive backs of the two badges before you secure them with the bolts from the last step.



58. Slide the rear of the lid under the 4 pre-installed M8x30mm bolts.



59. **Torque the lid bolts to 18 ft-lbs. following the sequence from the diagram at the back of this manual.**



Section 5: Serpentine Belt, Throttle Body and Hose Installation

60. Install the provided belt following the routing diagram at the back of this manual. Rotate the tensioner counterclockwise as you did before to allow the slack necessary to install the belt over the supercharger pulley as the final belt location. Ensure that the belt is aligned over all the pulleys.



61. Apply Loctite 242 to the OEM throttle body bolts.



62. Gather the provided throttle body gasket shown.

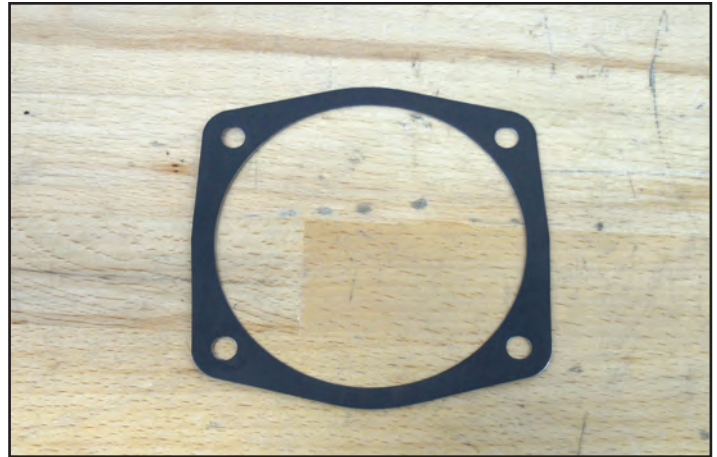

63. **Install the throttle body gasket from the last step** at the supercharger inlet followed by the throttle body with the electrical connection oriented towards the front as shown with the 4 bolts from two steps ago. Ensure that the throttle body does not interfere with other hose connections while installing. **Torque the 4 bolts to 108 in-lbs.**



64. Plug in the throttle body connection at the arrow.

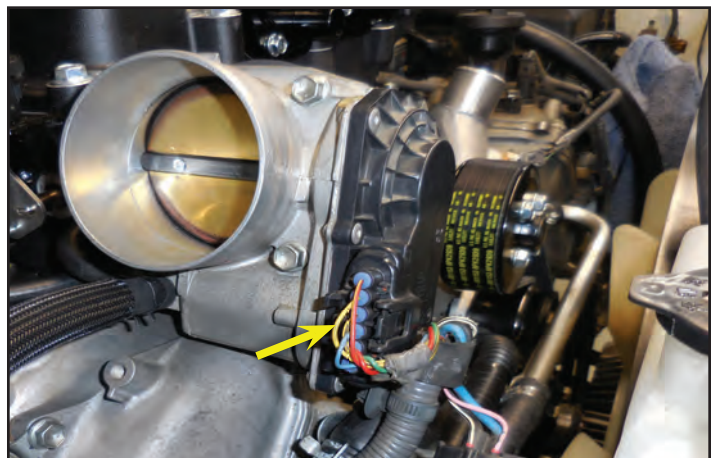

65. Install the coolant hose that was routed under the supercharger earlier to the rear facing connection of the throttle body (arrow location) and secure with the OEM spring clamp. Ensure that the hose isn't pinched under the supercharger.

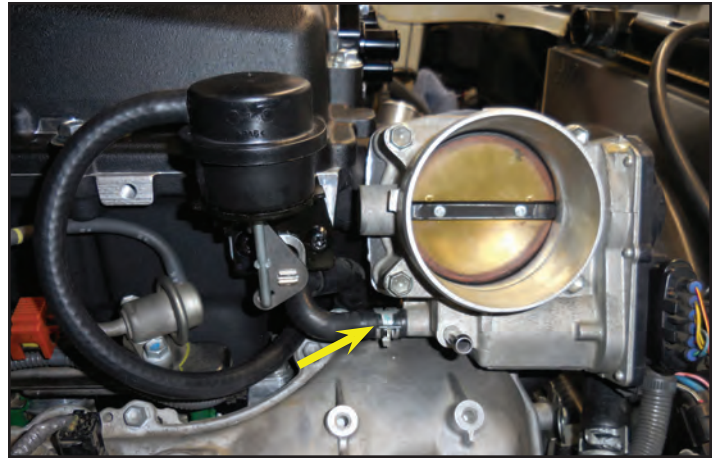

66. Install the provided spring clamps on the 3/8" Ø by 13" long coolant hose as shown.



67. Connect one end of the hose from the last step to the arrow location of the throttle body and secure with one of the spring clamps.

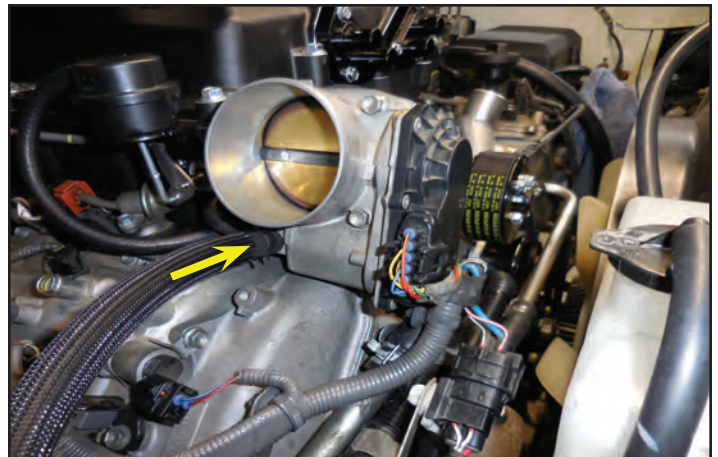

68. Connect the opposite end of the hose from the last step at the arrow location and secure with an OEM spring clamp.

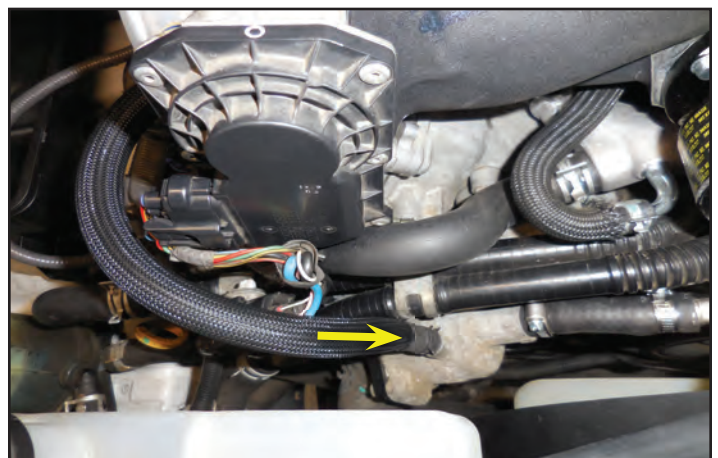

69. Install the provided air inlet tube to the throttle body with the provided worm drive clamp.



70. Insert the provided 1/8" barbed connector at the arrow location and install the hose from the fuel regulator to this location.



71. Install the provided 1/2" Tee at the arrow location. Install the provided 1/2" ID X 27" long EVAP hose to the Tee fitting using an OEM spring clamp.



72. Install the 30" x 3/4" Ø OD mesh to the 27" hose and secure the opposite end to the left valve cover at the arrow location and secure with an OEM spring clamp.



73. Gather the hose assembly that was removed earlier and remove the section highlighted in green.

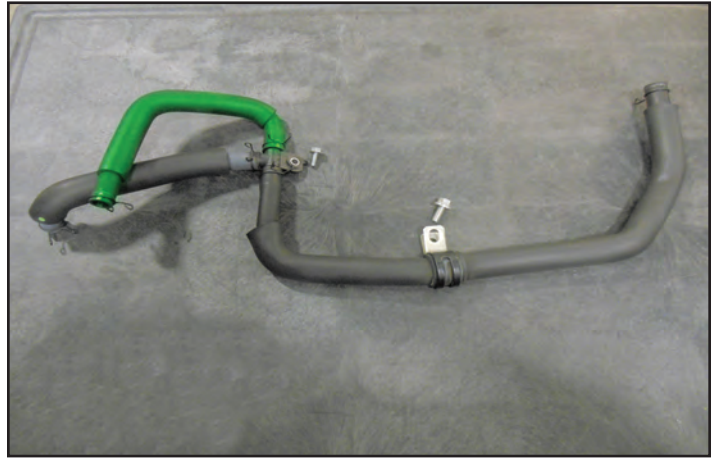

74. Cut the hose that was removed in the last step just before the bend as shown here. The shorter section will be saved for the next step.



75. Install the section of hose that was cut in the last step between the Tee and the right valve cover vent tube as shown here at the arrows and secure with two OEM spring clamps.

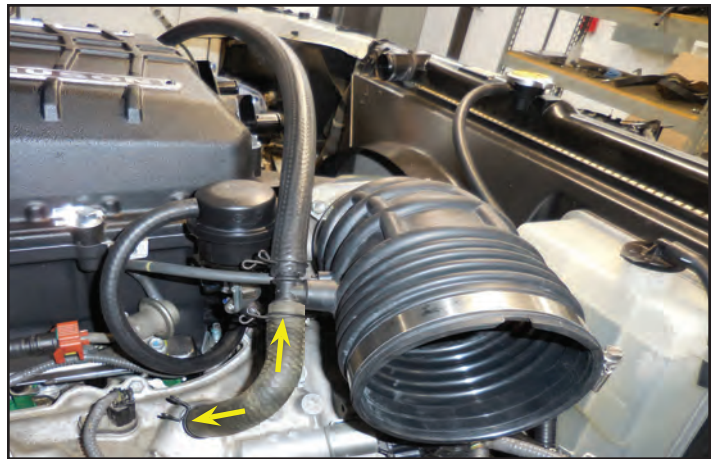

76. Inspect your filter now to ensure it is clean.



77. Insert the airbox lid at the arrow location at the air inlet.



78. Secure the airbox lid with the 4 spring clips.



79. Secure the inlet with the provided hose worm drive clamp.



80. Plug in the MAF electrical connection at the yellow arrow and secure the wire to the lid at the green arrow.



81. Gather the M6x10mm button head bolt and star washer that was removed earlier. Apply Loctite 242 to the bolt as shown.

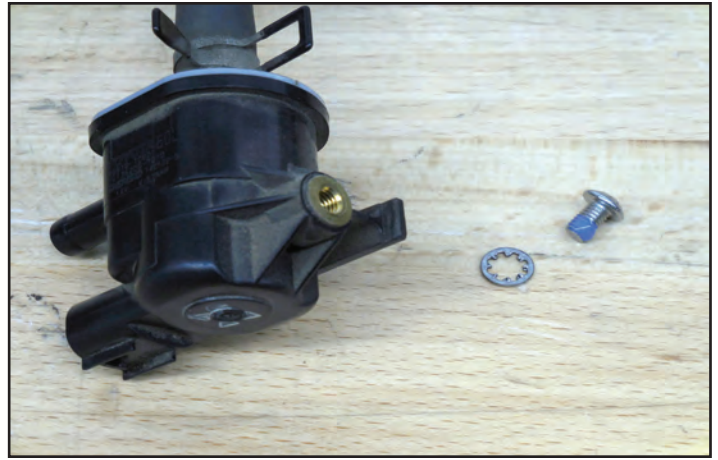

82. Secure the reservoir with the 3 bolts at the yellow arrows into the provided bracket. Install VSV at the green arrow location with the star washer and button head bolt from the last step.

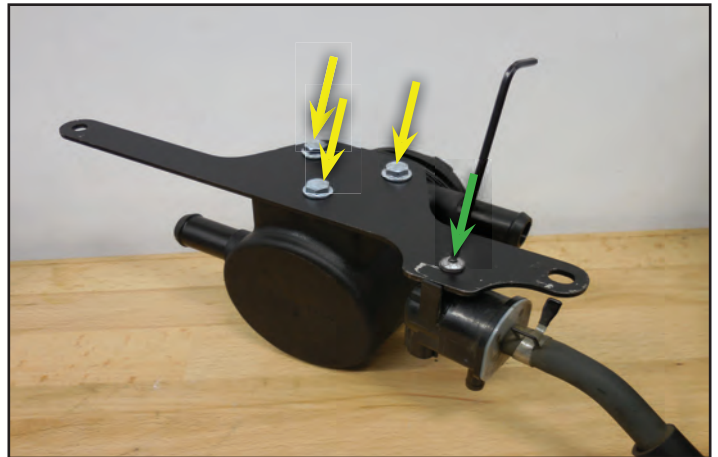

83. Apply Loctite 242 to the two provided M8x16mm bolts shown below and use them to install the bracket from the last step into the supercharger at the arrow locations. Torque these bolts to 108 in-lbs.



84. Cut approximately 2" from the hose on the VSV valve.



85. Connect the VSV hose to the bottom air tube on the supercharger inlet (arrow location).



86. Cut approximately 4" from the hose that goes to the other side of the VSV valve.



87. Connect the hose from the last step to the VSV valve (arrow location) and secure with the OEM hose clamp.



88. Secure the PCV hose onto the middle air tube on the supercharger at the arrow location and secure with the OEM spring clamp.



89. Gather the 26" section of 11/32" brake booster hose and install one side at the top barb of the supercharger and secure with an OEM clamp. Install the opposite side to the brake booster after routing it as shown. Ensure that you have secured the brake booster side with an OEM clamp as well.



90. Plug the VSV connector at the red arrow location. Wrap the ACIS connector with electrical tape and secure it to the electrical harness at the yellow arrow with a cable tie.



91. Flip the upper radiator hose so the radiator side now connects to thermostat neck on the engine. This is the orientation that will provide the most clearance for the hoses that will follow. This is also the orientation the hose had prior to having any supercharger installed.



92. Gather the 3/4" hose assembly with the "U" shaped end and connect it to the back of the reservoir using a provided spring clamp.



93. Route the hose from the last step through the lower slot that was cut in the plastic side panel.



94. Trim the end of the hose from the last step just before the bend as shown here.



95. Shorten the mesh covering by approximately 2 inches and secure it with the provided heat shrink tubing using a heat gun. Install the hose on the input of the coolant pump and secure with a provided spring clamp.

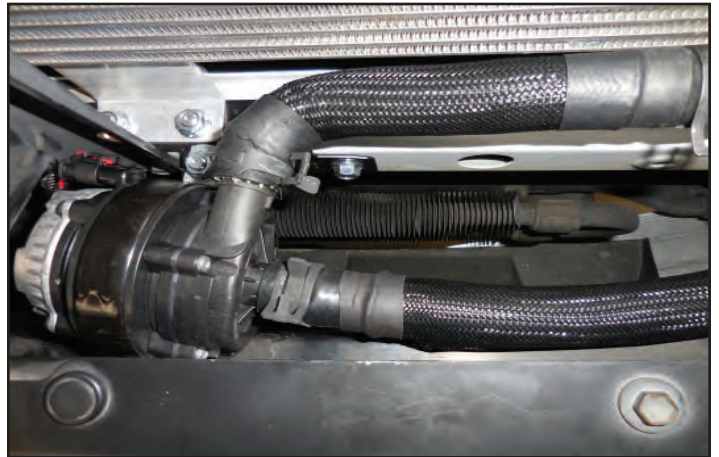

96. Gather the following hose assembly.



97. Secure the **provided 49"** long hose with mesh on it to the end of the hose assembly with a provided heat shrink clamp using a heat gun as shown. Ensure that the hose has gone to the stop on the plastic 3/4" Tee. Ensure that the hose clamp is approximately 1/8" from the end of the hose and that it has shrunk enough to seal the hose completely. The hose clamp should have a slight peak at the center of it like the other shrink clamps. Test the connection by pulling on it.



98. Install the hose assembly from the last step into the two lower spigots of the supercharger and secure with the provided spring clamps. Ensure that the clamp tabs point inwards as shown to give clearance for the upper hose assembly installation.



99. Route the 49" hose from the last step as shown here highlighted in green.



100. Route the 49" hose from the last step through the upper hole that was made in the plastic side curtain as shown here highlighted in green.



101. Trim the end of the hose to the length required to attach it on the upper LTR hose barb. Shorten the mesh covering by approximately 2 inches and secure it with the provided heat shrink tubing using a heat gun. Secure the connection with a provided spring clamp.

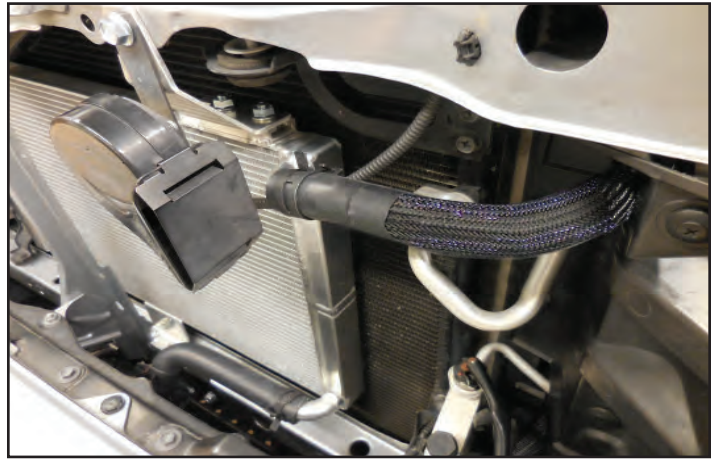

102. Gather the hose assembly shown.



103. Install the hose assembly from the last step into the two upper spigots of the supercharger and secure with the provided spring clamps.



104. Connect the opposite end of the hose assembly from the last step to the reservoir at the arrow location and secure with a provided spring clamp.



105. Gather the two large tie wraps, and the swivel spacer shown below. Slide the tie wraps from the last step through the swivel spacer to allow the connection of the two hoses shown with an arrow. **Do not crush either hose with the tie wraps.**

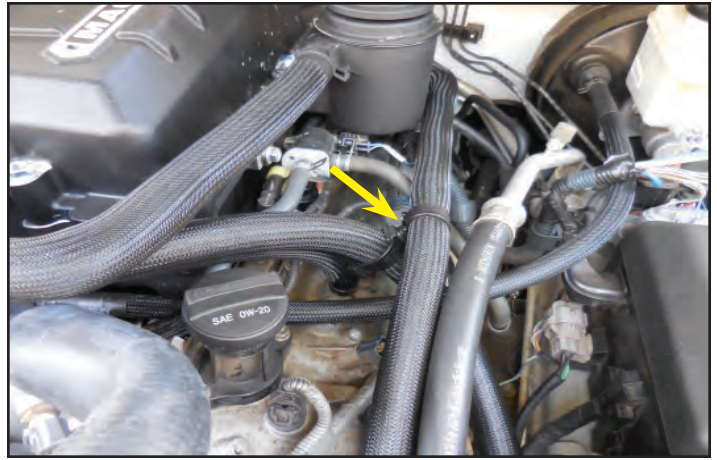

106. Use another provided cable tie to loosely secure the two hoses at the arrow location.

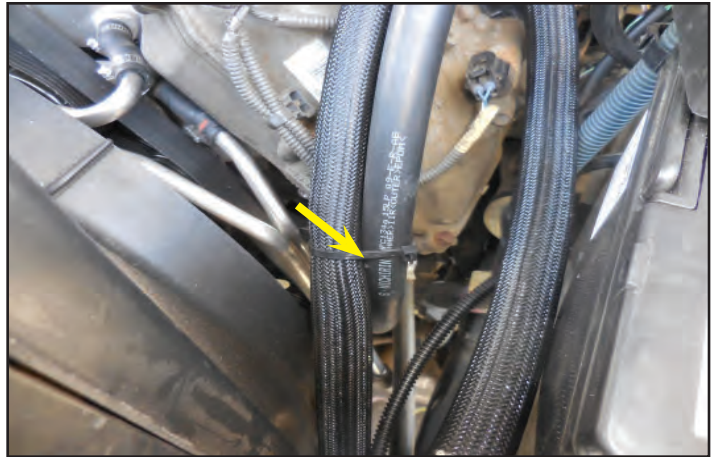

Section 6: Coolant Fill, and Final Testing

107. Ensure that the drain plug for the radiator is closed. Fill the radiator with a Toyota approved coolant mixture. Re-install the radiator cap. If you saved and reused your coolant, make sure it all gets reused. You may need to add some to the overflow tank to the right of the radiator.



108. Reconnect the negative lead of the battery and tighten the nut with a 10 mm wrench.



Make sure that you have followed step #1 in this manual to load the proper supercharger calibration to your vehicle's ECM.



109. Fill the intercooler reservoir with a Toyota approved coolant mixture until it is full. Have someone else cycle your ignition switch to the accessory mode to trigger the pump on. **Do not start the vehicle!** This will circulate the fluid. Once the reservoir drains turn the pump off, and fill again. **Do not allow the reservoir to run dry.** Repeat until full circulation is achieved with a full reservoir. Fluid level should be just above the top barb. Re-install the reservoir cap.



110. Check the serpentine belt to see that it is aligned properly on all the pulleys. Start the engine and let it idle. Check for fuel, and coolant leaks. Squeeze the inlet and outlet hose on the radiator to remove trapped air from the system. Check the air intake for leaks, and tighten any loose fittings. Shut down the engine, and allow it to cool. At this time you can reinstall the skid plate that was removed in section #2. Also if you have a 2014+ truck reinstall the front grille.



111. Once the engine has cooled down check the level of the radiator reservoir, and the intercooler reservoir. Add coolant if necessary. Test drive the vehicle for the first few miles under normal driving conditions. **Do not perform any wide open throttle runs.** Check for any unusual sounds, vibrations, or engine misfires. The supercharger does have a slight whining noise under boost conditions, which is normal. After the initial test let the engine cool down, and recheck coolant levels.



112. After the initial test drive gradually work the vehicle to wide open throttle runs. Listen for any engine detonation (pinging). If engine detonation is detected let up on the throttle immediately. Most detonation is caused by low octane gasoline still in the tank. Premium 91 octane fuel is required. Enjoy your new supercharger!

If you have questions about your vehicles performance, please check with your installation facility.

After you finish your installation and road test your vehicle, please fill out the warranty registration. This can be found on our website.

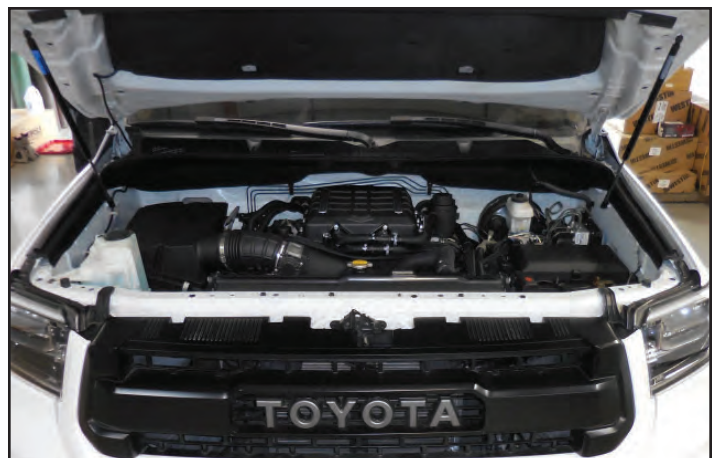

Appendix A

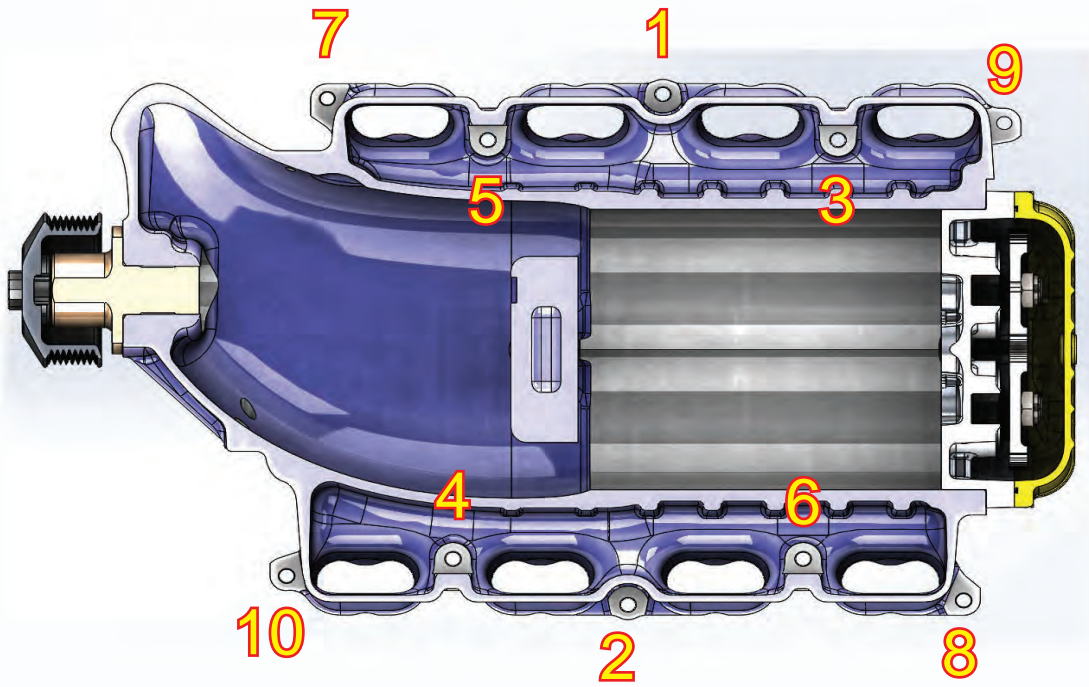

**Supercharger Torque Sequence
(15 ft-lbs. Final Torque)**

Appendix B

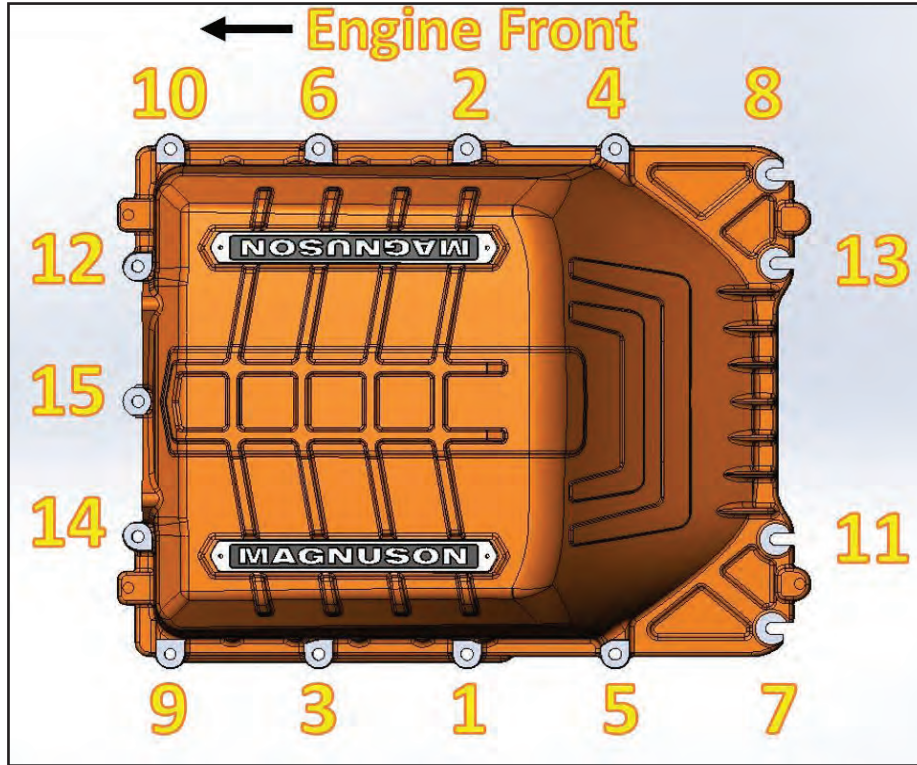

**Lid Torque Sequence
(18 ft-lbs. Final Torque)**

Appendix C

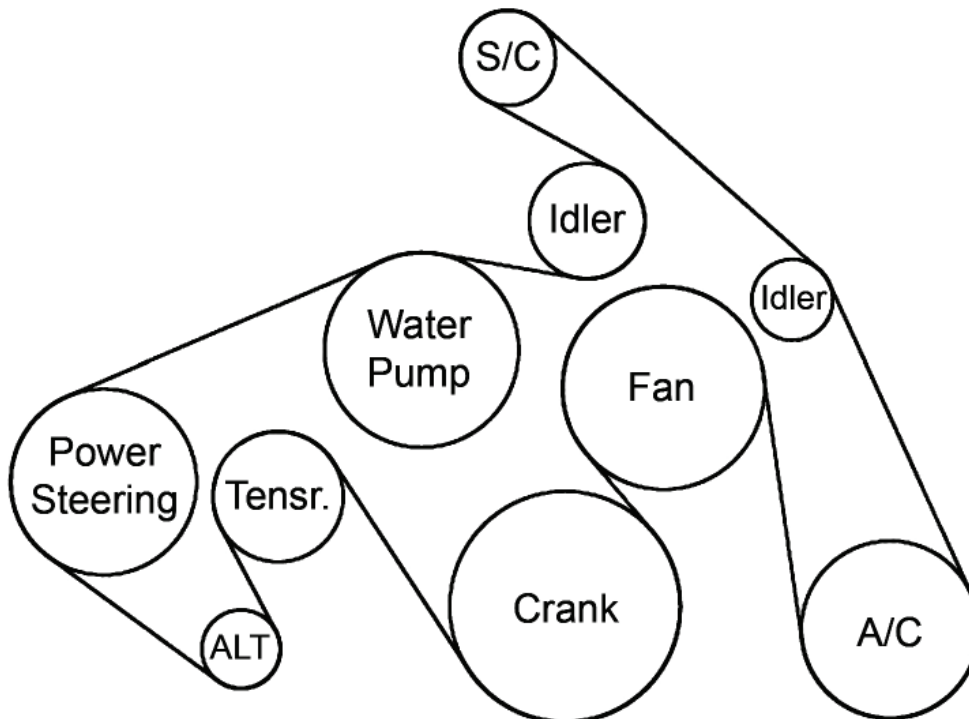

Belt Routing Diagram

Notes



Use only premium gasoline fuel, 91 octane or better.

MAGNUSON
SUPERCHARGERS